

Monte Vista Parking Entrance

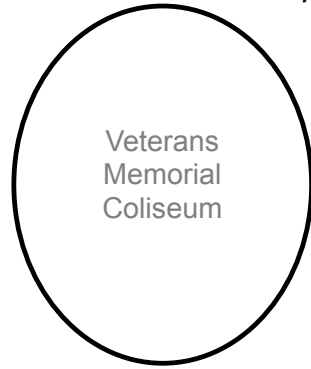

January 11,12,13, 2019
SHOW
OVERVIEW

Vendor parking is located off-site at 19th Ave. & Monte Vista Parking Lots. Free Shuttle service will be provided for all vendors from the Vendor Lots to both show entrances.

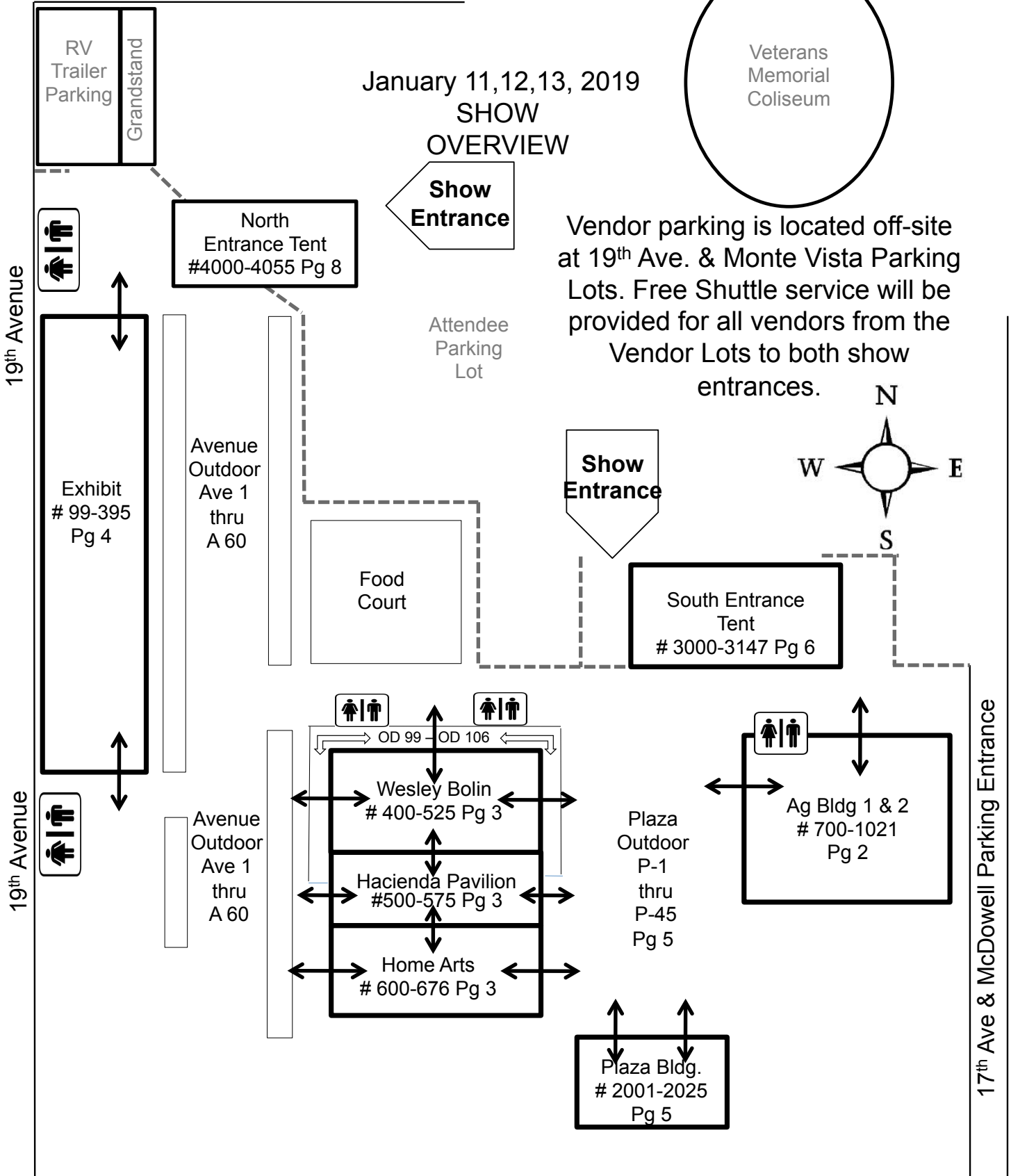
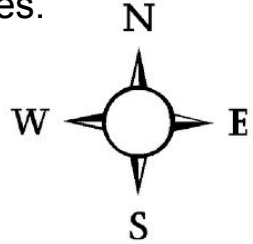

Area Description: These are 3 Separate Buildings that share the same roof and side-walls. This is the middle of the Show between both gated entrances and directly in front of the food court.

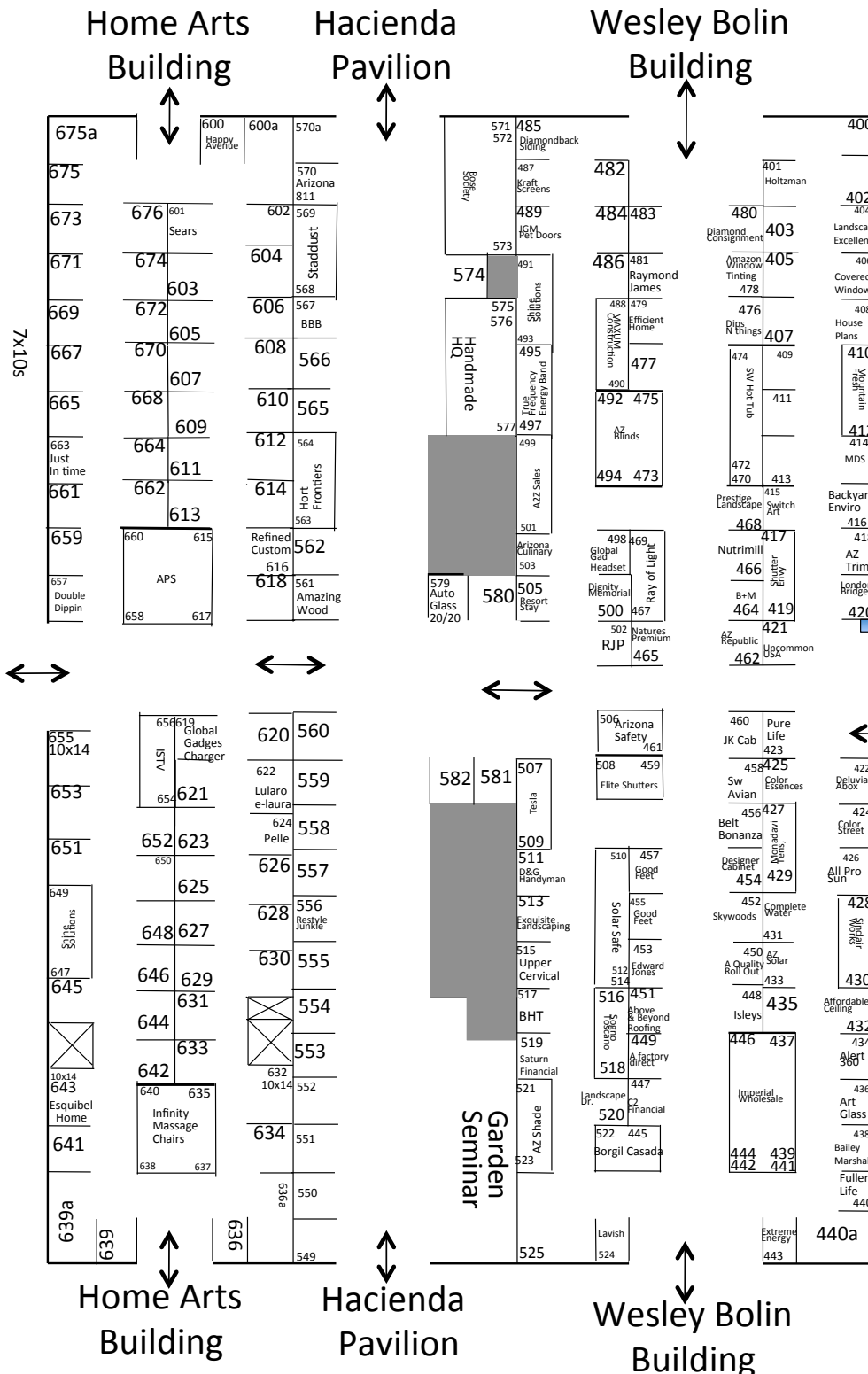

Wesley Bolin: Fully enclosed with concrete flooring. Climate controlled with Evaporative Cooling & Heaters.
8 x 10's
 Inline: \$953
 Corner: \$1428
 Pavilion Corners 525
 approx 240 sq ft.: \$2060.00
 440a-8x20 w/ 10ft opening-\$1465

Hacienda Pavilion: Has roof & side walls and is open-air breezeway with gates on either end, black top flooring. No climate control.
10 x 10's
 Inline: \$850
 Corner: \$1020
 586-589: 10 wide x8 deep open on all 3 sides \$1020
 590, 591: 6 wide x 10 deep , open on all 3 sides \$765

Home Arts: Fully enclosed with concrete flooring. No Climate control.
10 x 10's = 601-637, odds 641-655, evens 658--675
 Inline: \$1191
 Corner: \$1786

7 x 10's = evens 638-656; odds 657-673
 Inline: \$833
 Corner:\$1250

Misc - #'s & Pricing Below:
 643 10 x 14 Inline: \$1667.40
 Pavilion Corners: 600a, 636a, 639a
 Approx 200 sq ft \$1947.60
 #675a Approx 140 sq ft.: \$1786
 #655 10x14 corner:\$2500

Multiple Booth Discount:
 2- 5 booths: 10%
 6 + booths: 15%
 Pavilion Corners do not qualify for multiple booth discounts.

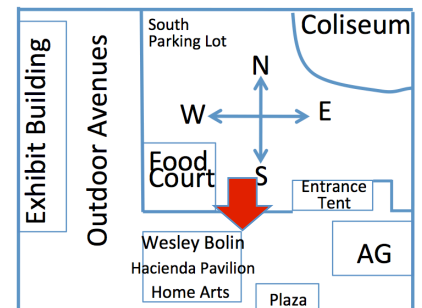

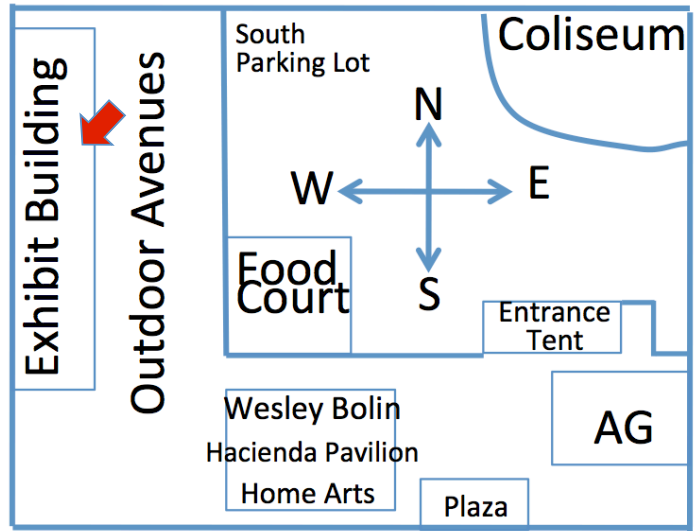
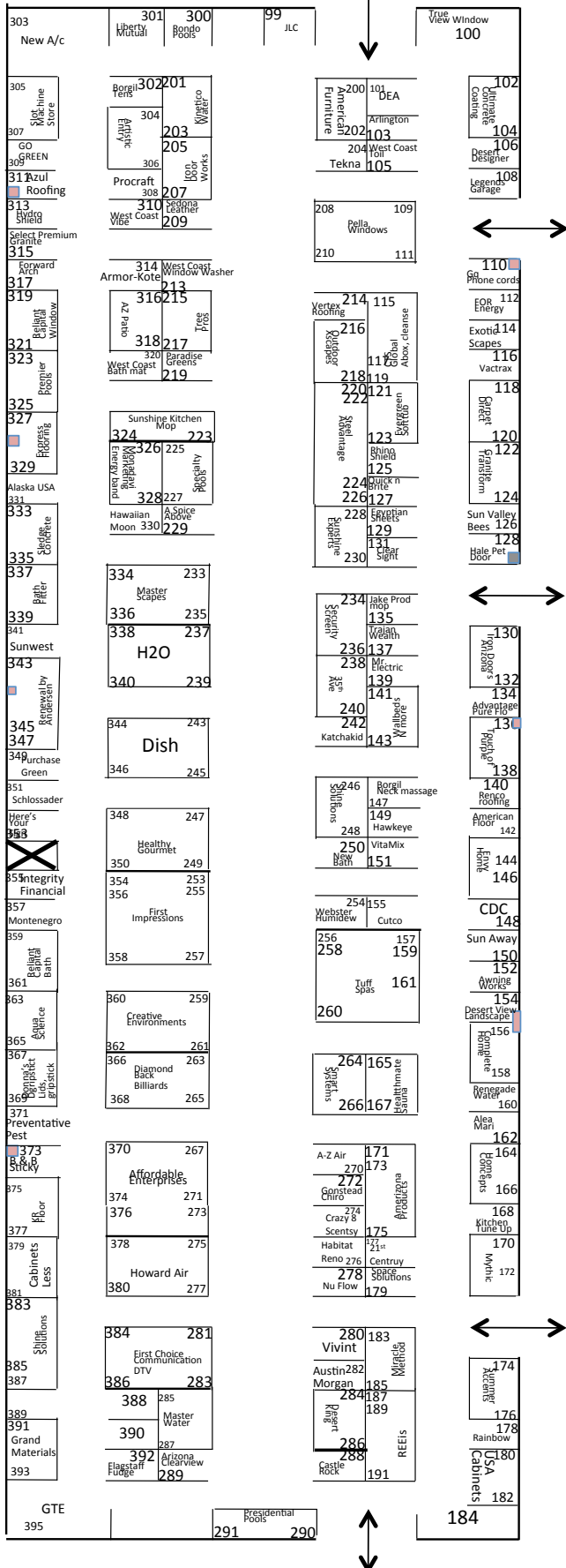

Exhibit Building

Building Descriptions:

Fully enclosed with concrete flooring. Climate controlled with Evaporative Cooling & Heaters. Heating Units are marked with ■ and some hang as low as 7 feet from the floor. All Booths are 10 x 10 or multiples there of with the exceptions of Booths 100, 303, & 395 which are Pavilion Corners (approximately 300 sq feet).

Pricing:

10 x 10 Inline: \$1191
 10 x 10 Corner: \$1786
 Pavilion Corners: \$2575.00
 184 = 10x20 corner: \$2143
 All Booths Plus 2.6 % Tax

Multiple Booth Discount:

2- 5 booths: 10%
 6 + booths: 15%

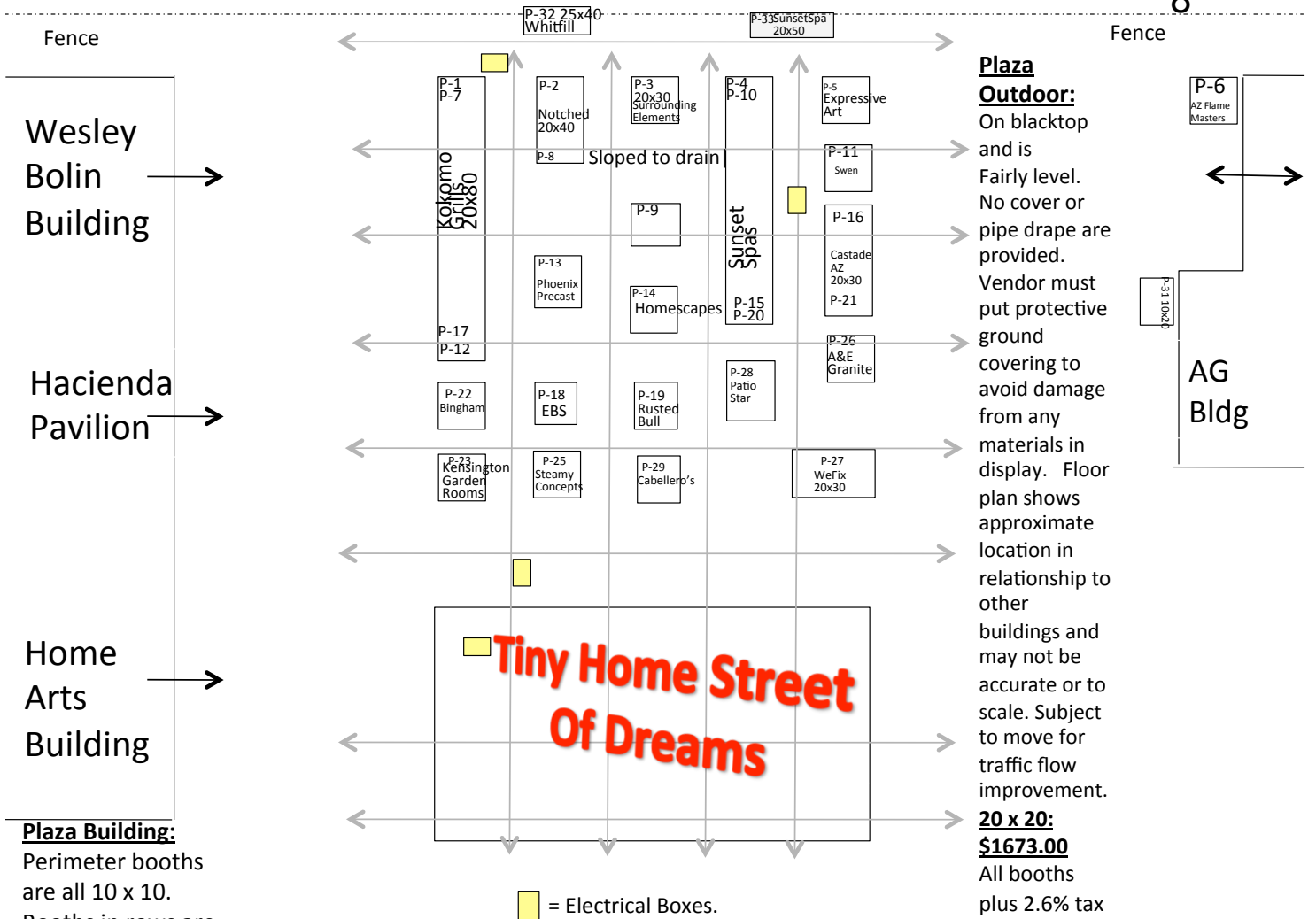

Plaza Building:

Perimeter booths are all 10 x 10. Booths in rows are all 6 x 10

10 x 10's:

Inline: \$1191
Corner: \$1786

6 x 10's:

Inline: \$715
Corner: \$1071

Pavilion Corners:

#2100 \$2143
#2001 & 2014 \$1947.60 ea
All Booths Plus 2.6 % Tax

Multiple Booth Discount:

2- 5 booths: 10%
6 + booths: 15%

Pavilion Corner + outdoor booths do not qualify for multiple booth discount.

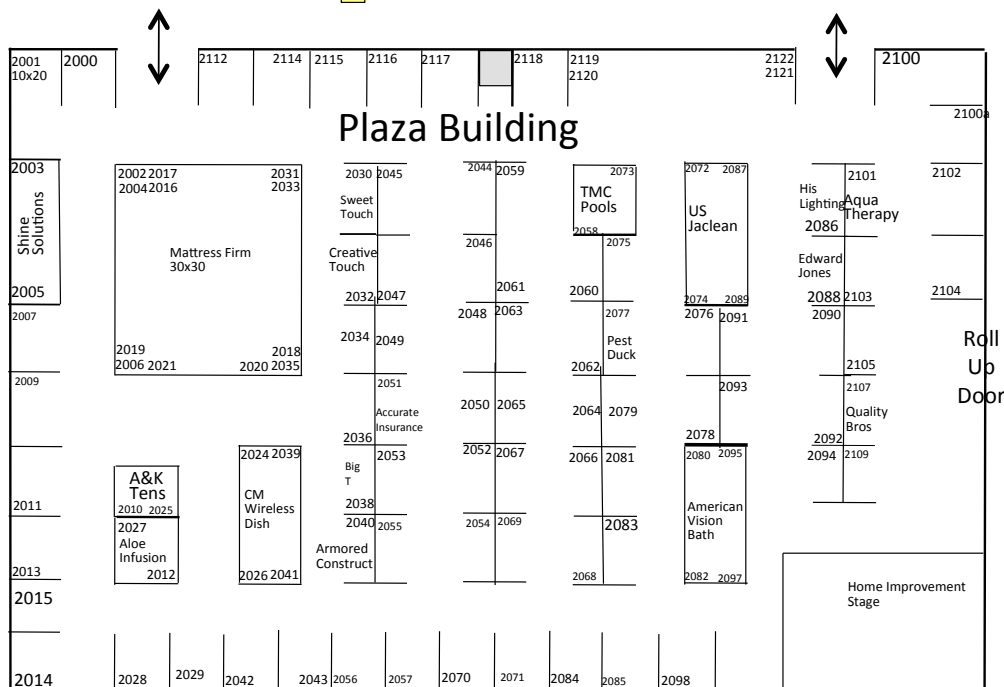

Plaza Building:
Fully enclosed with concrete flooring. Evaporative Coolers only. **NO HEATERS**

X Scooter Rentals

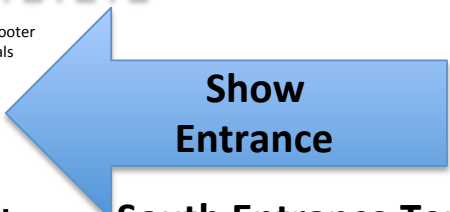
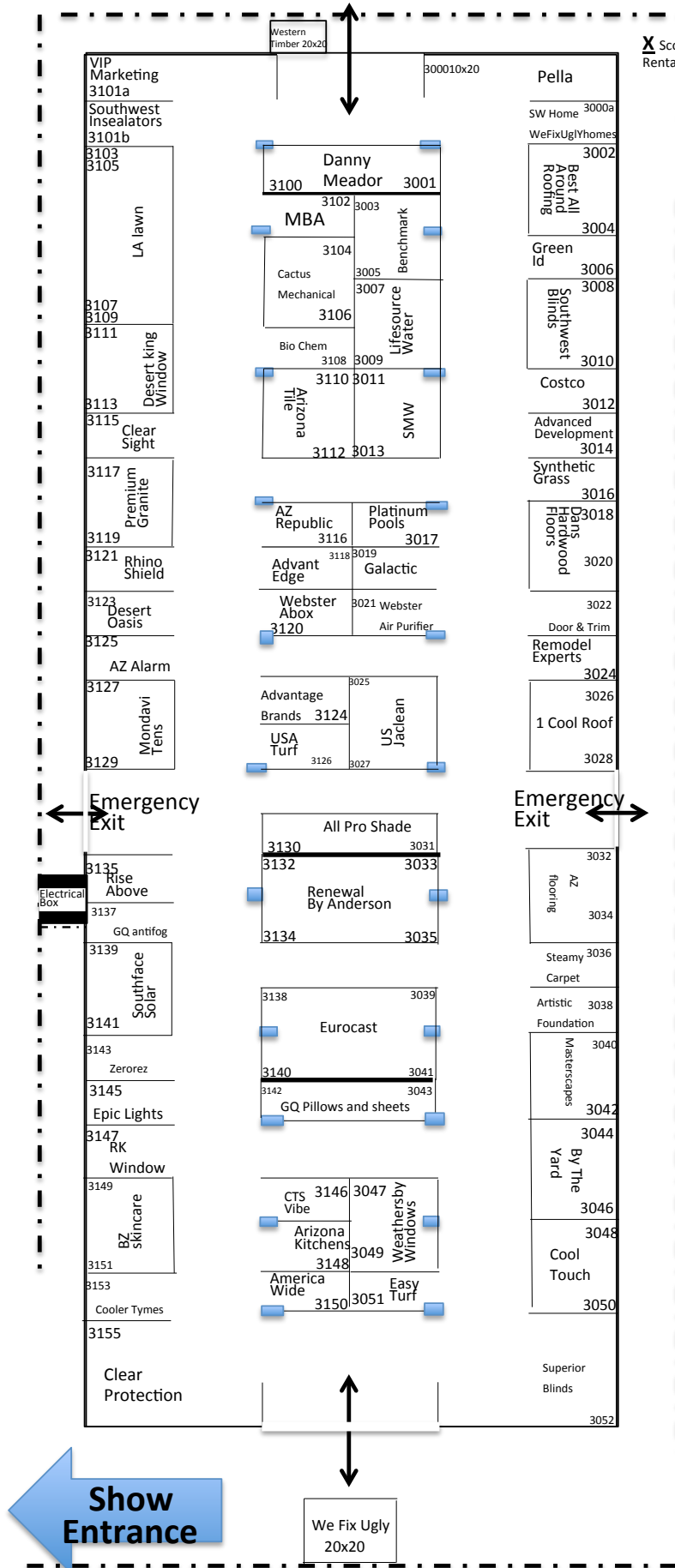

South Entrance Tent

Tent Descriptions:

Fully enclosed on Black Top.
Tent is not climate controlled.
There is overhead lighting and electricity available.

All Booths are 10 x 10 or multiples there of with the exceptions of Booths 3000, 3054, 3155.

■ Indicates Support Pillar

Pricing:

- 10 x 10 Inline: \$1191
- 10 x 10 Corner: \$1786
- Pavilion Corners: \$2575.00
- All Booths Plus 2.6 % Tax
- #3000 and #3054 are 10x20 corner: \$2679.30

Multiple Booth Discount:

- 2- 5 booths: 10%
- 6 + booths: 15%

All center row booths have a tent support pillar, please plan accordingly.

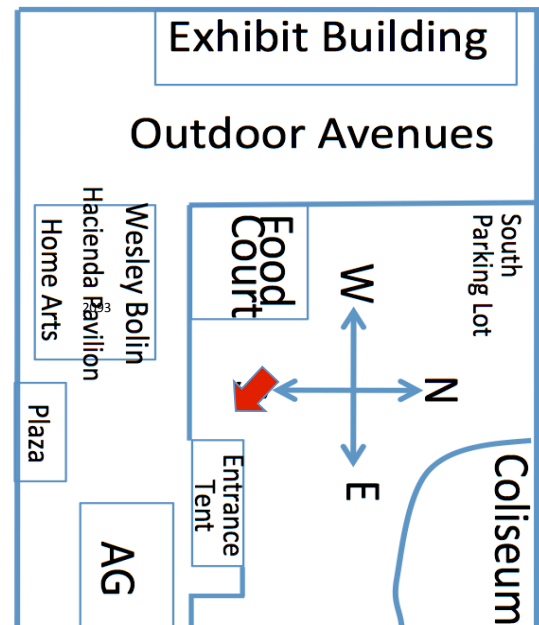

Maricopa County Home Shows
602-485-1691
January 11,12,13, 2019

North Entrance Tent

Tent Descriptions:

Fully enclosed on Black Top.
Tent is not climate controlled.
There is overhead lighting and electricity available.

All Booths are 10 x 10 or multiples there of with the exceptions of Booths#’s4000, 4015, 4040, 4055

Pricing:

10 x 10 Inline: \$1191
10 x 10 Corner: \$1786.00
All Booths Plus 2.6 % Tax
#4000, #4015, #4040, and #4055 are 10x20 corners: \$2678

All Booths Plus 2.6 % Tax

Multiple Booth Discount:

2- 5 booths: 10%
6 + booths: 15%
Indicates Support Pillar
All center row booths have a tent support pillar, please plan accordingly.

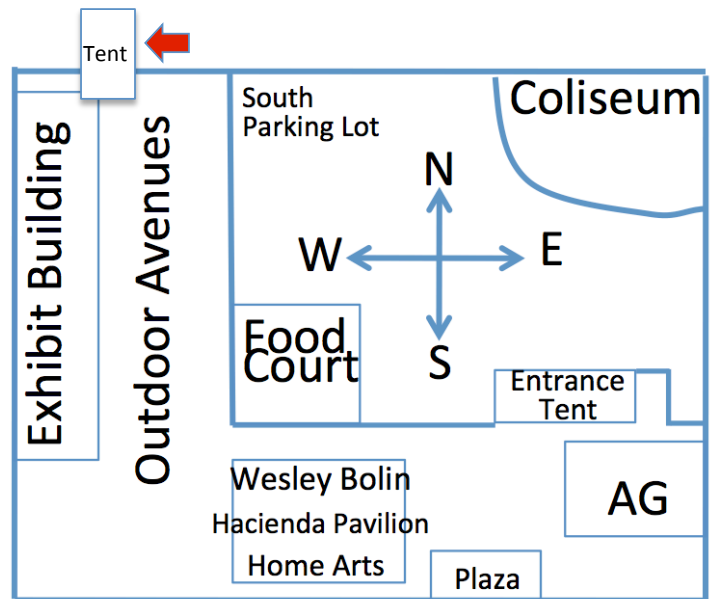
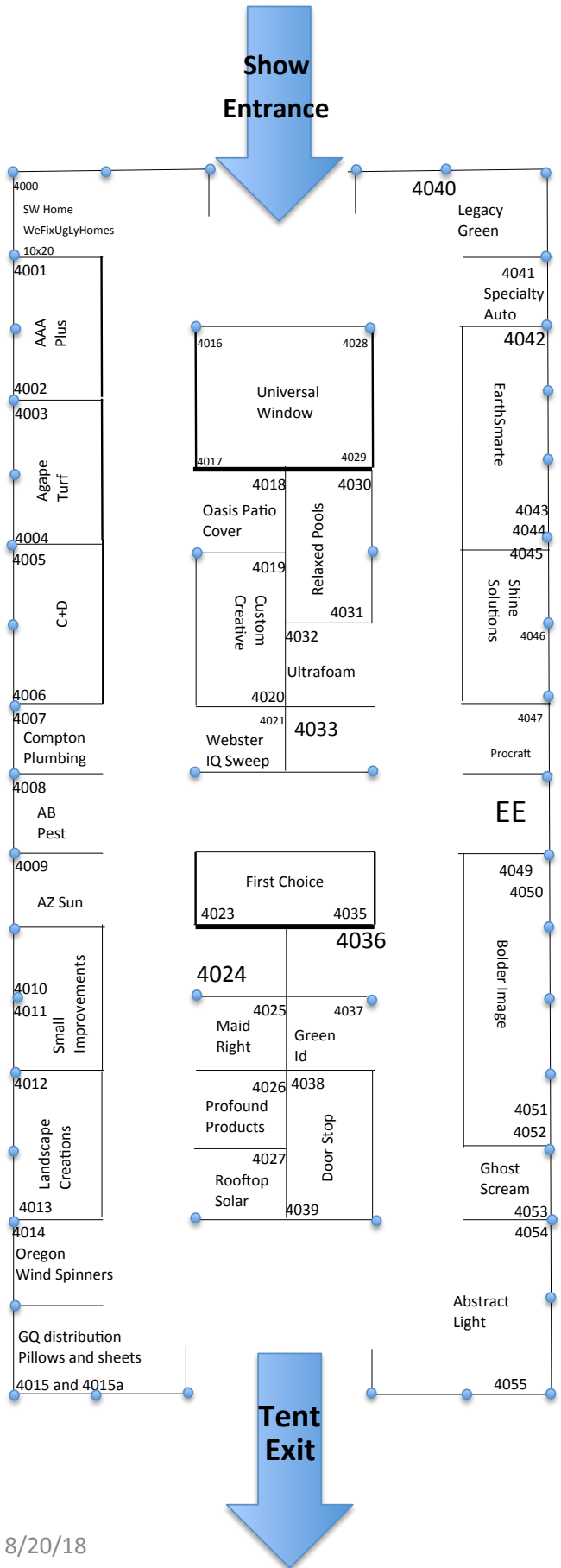

8/20/18

Arizona State Fairgrounds