

Monte Vista Parking Entrance

January 11,12,13, 2019
SHOW
OVERVIEW

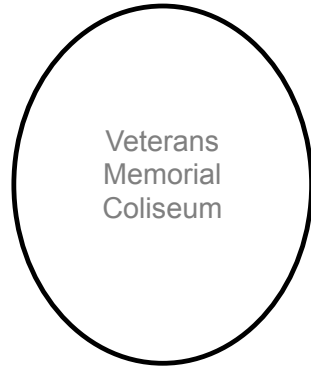

Vendor parking is located off-site at 20th Ave. & Encanto Parking Lots. Free Shuttle service will be provided for all vendors from the Vendor Lots to both show entrances.

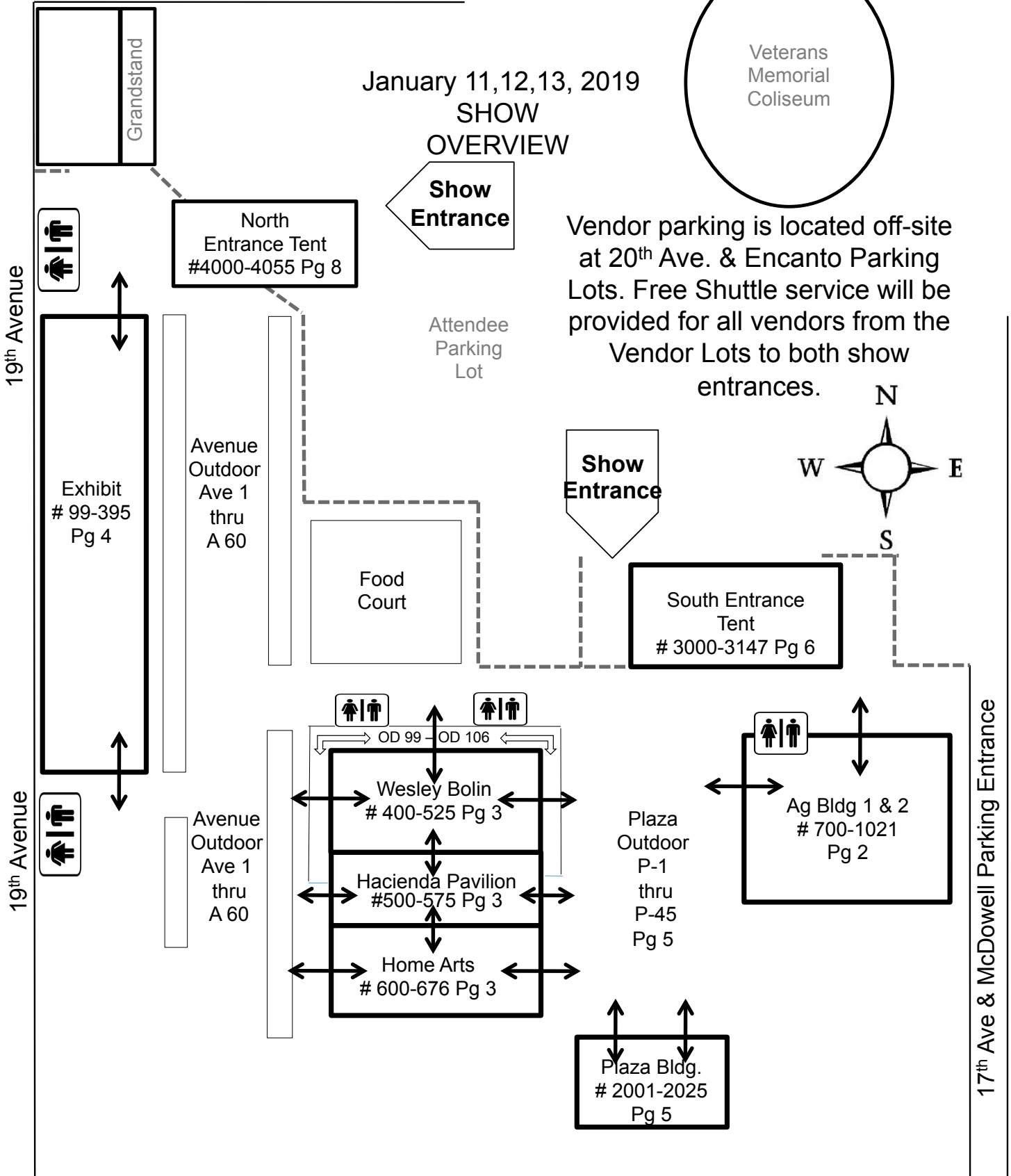
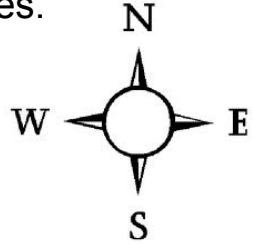

602-485-1691

Maricopa County Home Shows

12/31/18

Agricultural Building

Building Description:

Fully enclosed with concrete flooring. Climate controlled with Evaporative Cooling & Heaters.

8 x 10's = 700-713, 746-773, 806-832, 1005, 1007, 1009, 1011, 1013, 1015, 1017

Inline: \$953

Corner: \$1428

10 x 10's = All other booth numbers unless on Miscellaneous list:

10 x 10 Inline: \$1191

10 x 10 Corner: \$1786

Miscellaneous = #'s & Pricing below:

#847 168sq. Ft. Pavilion Corner: \$3040.16

#829 8x14 Corner: \$2273

#831 & 1001 Pavilion Corner: \$2575

#865 & 871 8x16 Endcap: \$2287

#859 5x30 endcap \$2500

#849 5x10 Corner \$893

All Booths Plus 2.6 % Tax

Multiple Booth Discount:

2- 5 booths: 10%

6 + booths: 15%

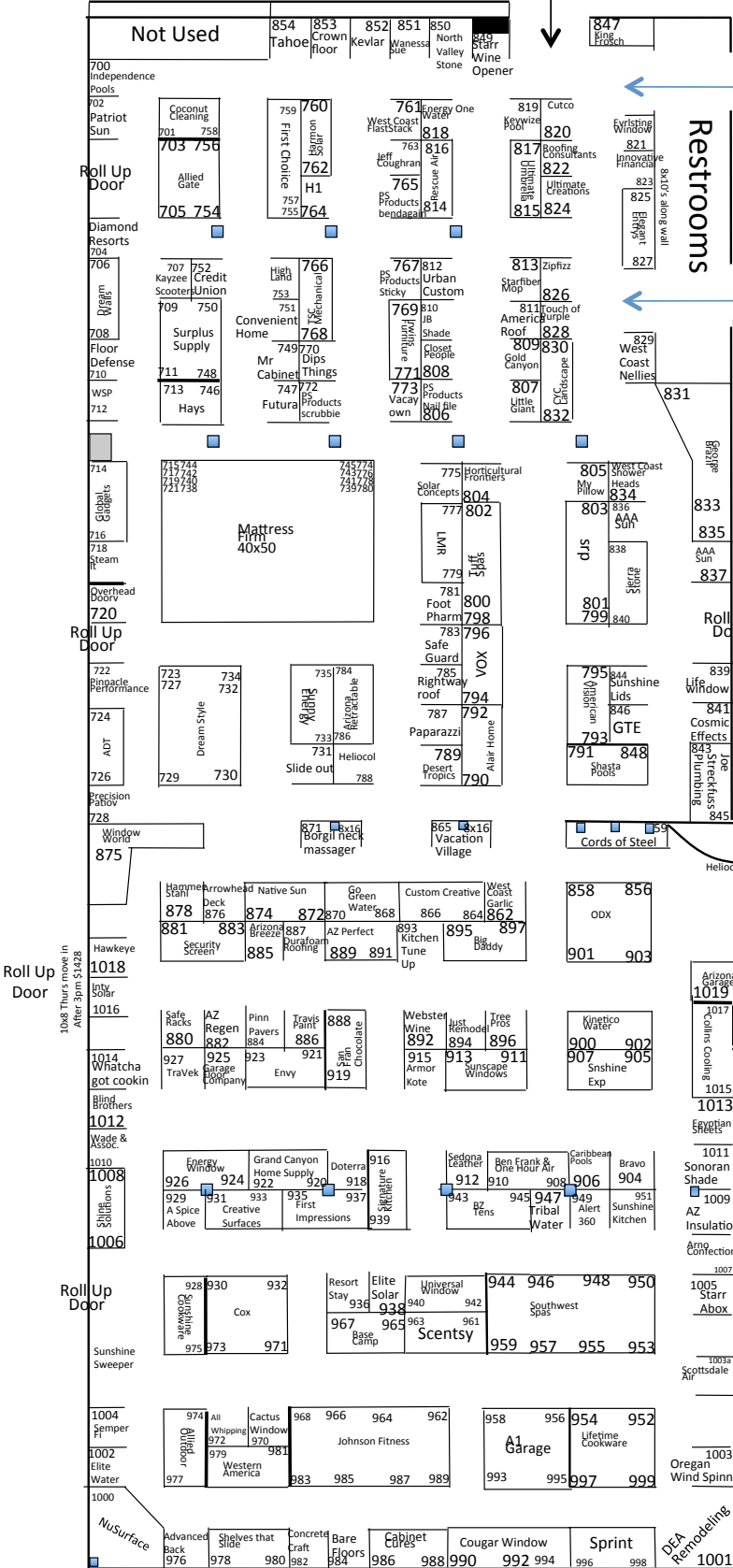

Restrooms

Roll Up Door

Roll Up Door

Roll Up Door

Roll Up Door

Show Entrance

■ = Structural Support Pillar- approx 2'x2'. Pillar location is approximate and map is not to scale.

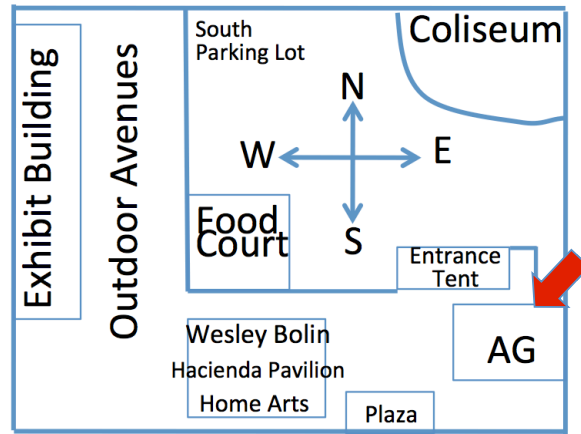

Arizona State Fairgrounds

Area Description: These are 3 Separate Buildings that share the same roof and side-walls. This is the middle of the Show between both gated entrances and directly in front of the food court.

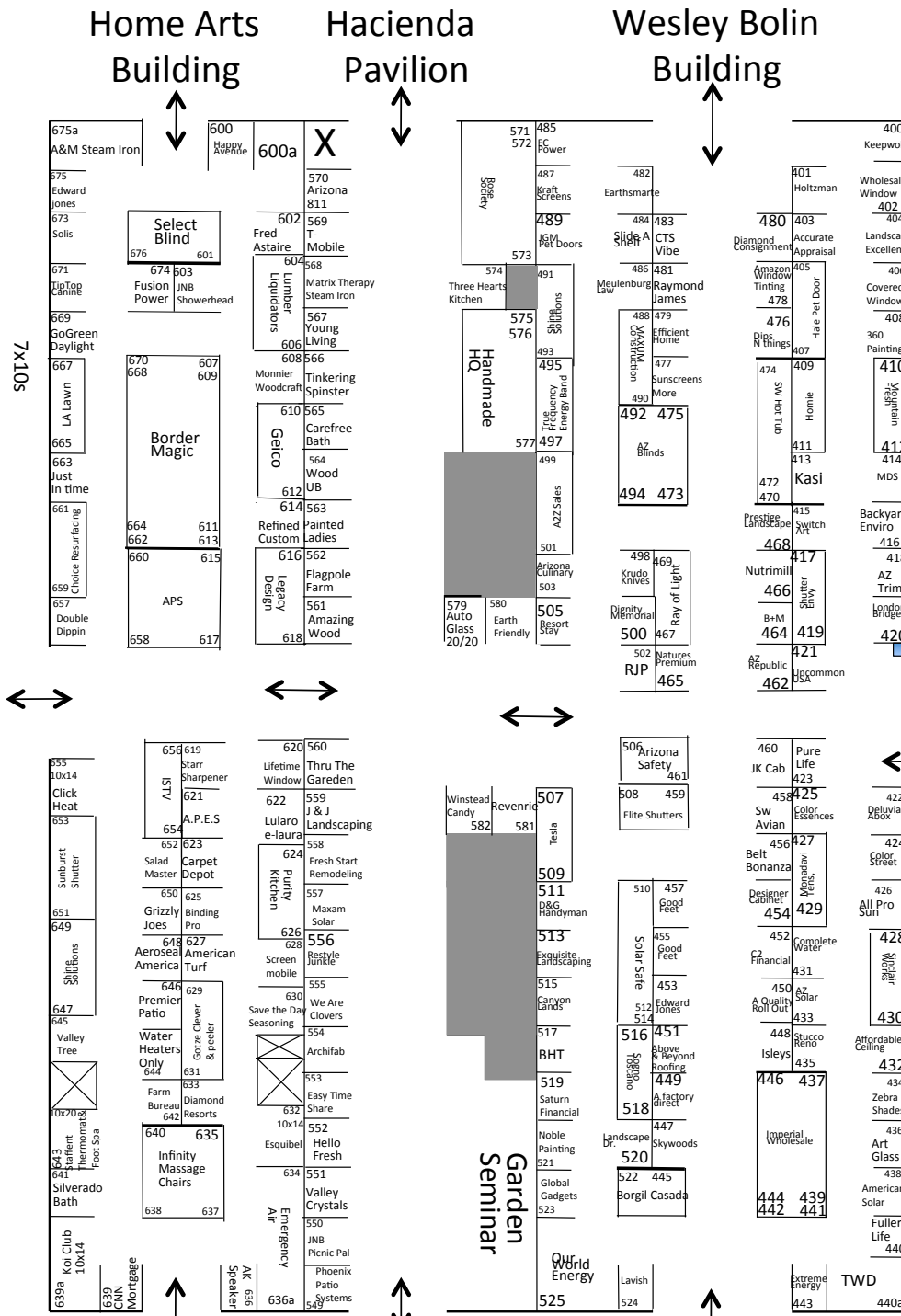

Wesley Bolin: Fully enclosed with concrete flooring. Climate controlled with Evaporative Cooling & Heaters.
8 x 10's
 Inline: \$953
 Corner: \$1428
 Pavilion Corners 525
 approx 240 sq ft.: \$2060.00
 440a-8x20 w/ 10ft opening-\$1465

Hacienda Pavilion: Has roof & side walls and is open-air breezeway with gates on either end, black top flooring. No climate control.
10 x 10's
 Inline: \$850
 Corner: \$1020
 586-589: 10 wide x8 deep open on all 3 sides \$1020
 590, 591: 6 wide x 10 deep , open on all 3 sides \$765

Home Arts: Fully enclosed with concrete flooring. No Climate control.
10 x 10's = 601-637, odds 641-655, evens 658--675
 Inline: \$1191
 Corner: \$1786

7 x 10's = evens 638-656; odds 657-673
 Inline: \$833
 Corner:\$1250

Misc - #'s & Pricing Below:
 632 & 643 10 x 14 Inline: \$1667.40
 Pavilion Corners: 600a, 636a, 639a
 Approx 200 sq ft \$1947.60
 #675a Approx 140 sq ft.: \$1786
 #655 10x14 corner: \$2262.40

Multiple Booth Discount:
 2- 5 booths: 10%
 6 + booths: 15%
 Pavilion Corners do not qualify for multiple booth discounts.

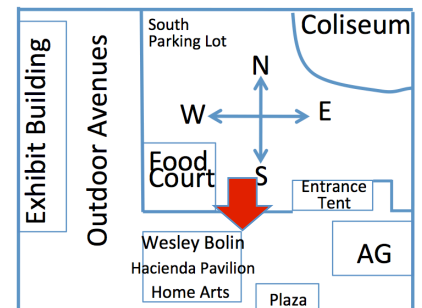

303 New A/c	301 Liberty Mutual	300 Pools	99 JLC	100 True View Window
305 Mike-line Store	302 Borel	201 Waterco		102 Arizona Contract
307 GO GREEN	304	203 Kinterco		104
309 Azul Roofing	306 Procraft	205 Works		106 Designer
313 Select Premium Granite	310 West Coast	207		108 Legends Garage
315 Forward Arch	314 West Coast	208 Pella Windows		110
317	Armor-Kote	210		112 For Energy
319	316	211		114 Exotid. Scapes
321	318	212		116 Vactrax
323	320	213		118
325	324	214		120
327	326	215		122
329	328	216		124
Alaska USA	329	217		126
331	330	218		128
333	334	219		130
335	336	220		132
337	338	221		134
339	340	222		136
341	342	223		138
343	344	224		140
345	346	225		142
347	348	226		144
349	349	227		146
351 Schlossader	350	228		148
353	354	229		150
355 Integrity Financial	356	230		152
357 Montenegro	358	231		154
359	360	232		156
361	362	233		158
363	364	234		160
365	366	235		162
367	368	236		164
369	369	237		166
371 Preventative Pest	370	238		168
373	374	239		170
375 Feet Solutions	376	240		172
377	378	241		174
379	380	242		176
381	384	243		178
383	386	244		180
385	388	245		182
387	390	246		184
389	392	247		186
391	394	248		188
393	396	249		190
395	398	250		192
Home	291	290		194

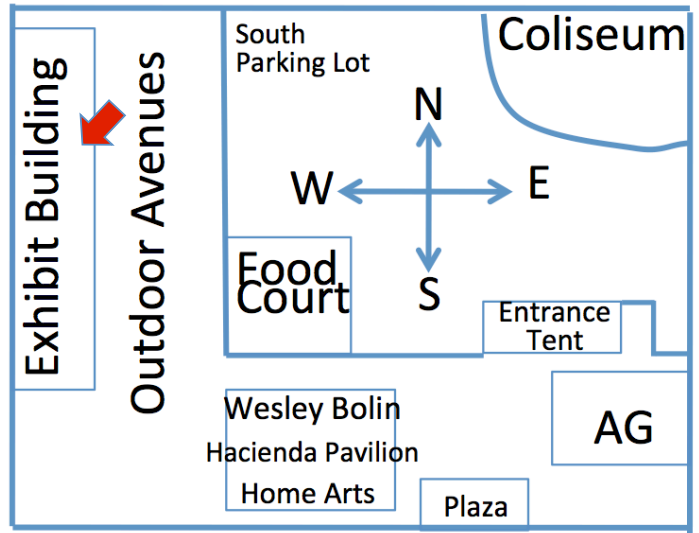

Exhibit Building

Building Descriptions:

Fully enclosed with concrete flooring. Climate controlled with Evaporative Cooling & Heaters. Heating Units are marked with and some hang as low as 7 feet from the floor. All Booths are 10 x 10 or multiples there of with the exceptions of Booths 100, 303, & 395 which are Pavilion Corners (approximately 300 sq feet).

Pricing:

10 x 10 Inline: \$1191
 10 x 10 Corner: \$1786
 Pavilion Corners: \$2575.00
 184 = 10x20 corner: \$2143
 All Booths Plus 2.6 % Tax

Multiple Booth Discount:

2- 5 booths: 10%
 6 + booths: 15%

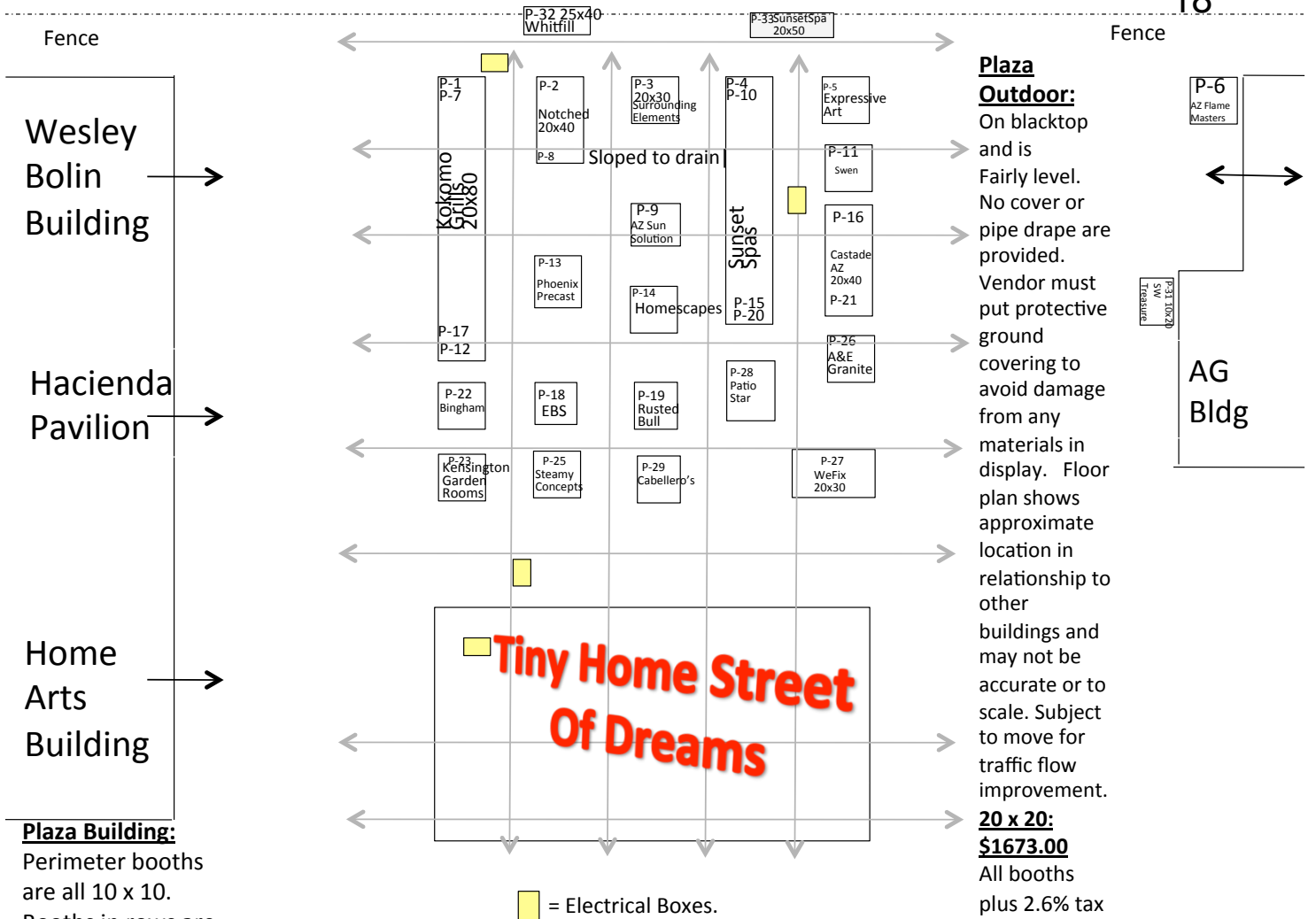

Plaza Building:
Perimeter booths are all 10 x 10. Booths in rows are all 6 x 10

10 x 10's:
Inline: \$1191
Corner: \$1786

6 x 10's:
Inline: \$715
Corner: \$1071

Pavilion Corners:
#2100 \$2143
#2001 & 2014 \$1947.60 ea
All Booths Plus 2.6 % Tax

Multiple Booth Discount:
2- 5 booths: 10%
6 + booths: 15%

Pavilion Corner + outdoor booths do not qualify for multiple booth discount.

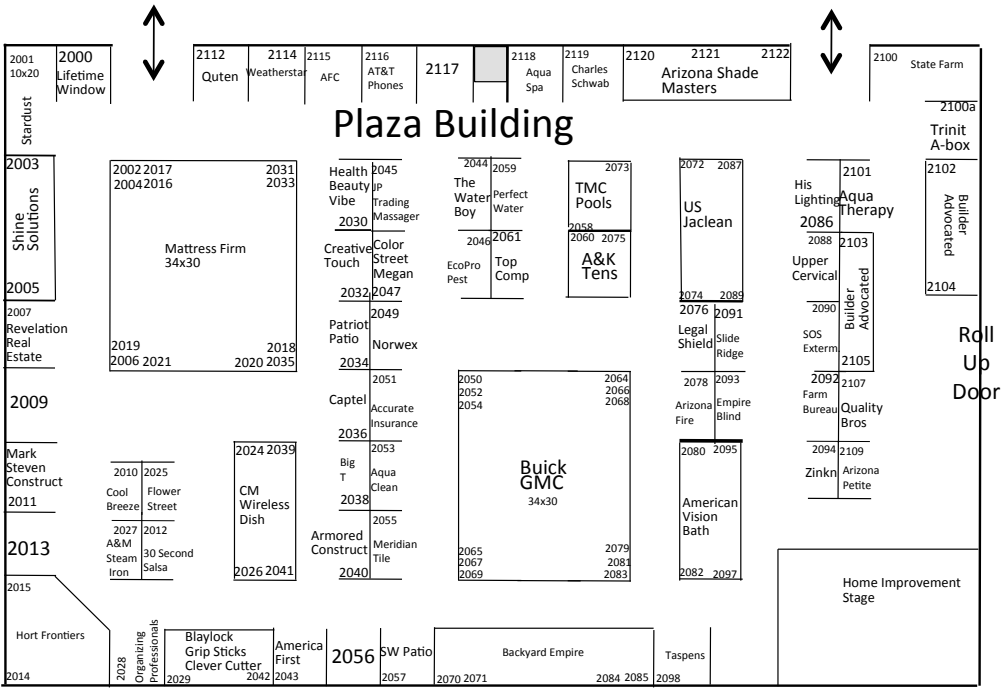

X Scooter Rentals

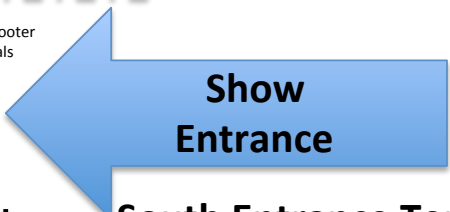

South Entrance Tent

Tent Descriptions:

Fully enclosed on Black Top.
Tent is not climate controlled.
There is overhead lighting and electricity available.

All Booths are 10 x 10 or multiples there of with the exceptions of Booths 3000, 3054, 3155.

■ Indicates Support Pillar

Pricing:

10 x 10 Inline: \$1191
10 x 10 Corner: \$1786
Pavilion Corners: \$2575.00
All Booths Plus 2.6 % Tax
#3000 and #3054 are 10x20 corner: \$2679.30

Multiple Booth Discount:

2- 5 booths: 10%
6 + booths: 15%

All center row booths have a tent support pillar, please plan accordingly.

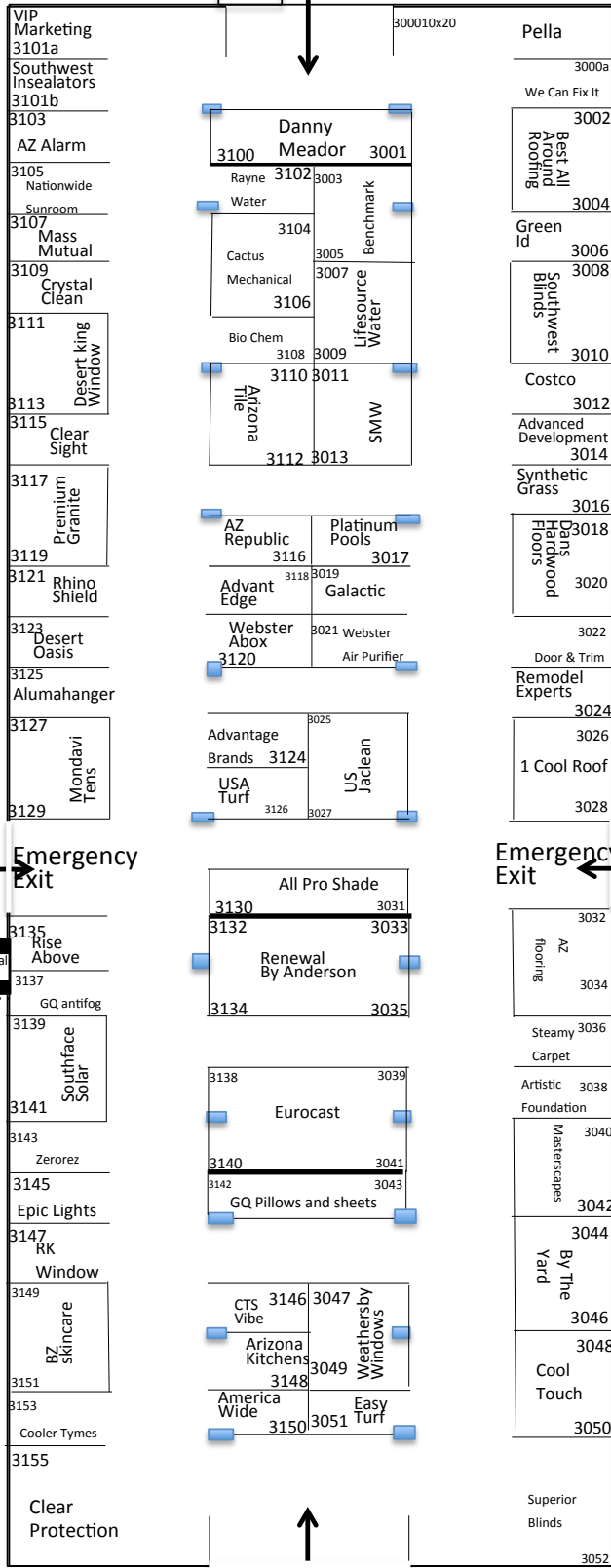
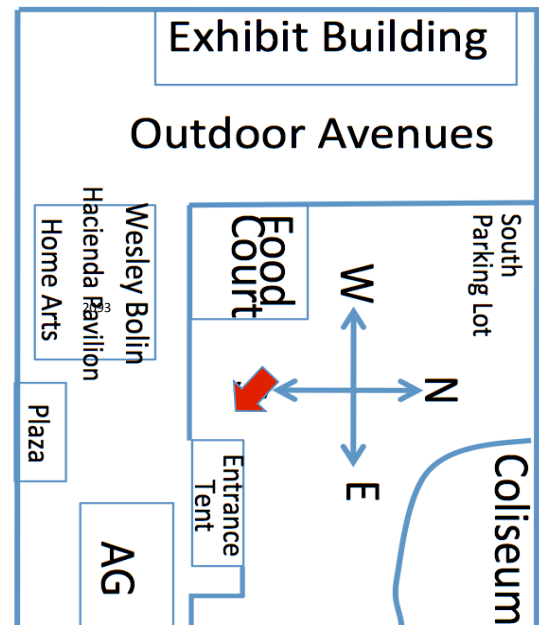

We Fix Ugly 20x20

Maricopa County Home Shows

602-485-1691
January 11,12,13, 2019

Avenue Outdoor & Outdoor

Overhang Booths: Booths are 20 x 20 and will be on either dirt & sidewalk, blacktop. No cover or pipe drape are provided. Vendor must put protective ground covering to avoid damage from any materials in display. Floor plan shows approximate location in relationship to other buildings and may not be accurate.

20 x 20 Ave & OD locations: \$1673

20 x 20 Under Overhang: #OD-92-OD-105: \$2060.00
OD- 88 & OD-89 10x20: \$836.50

All booths plus 2.6% tax.
Outdoor Booths are already sold at a Discount and do not qualify for the multiple booth discount.

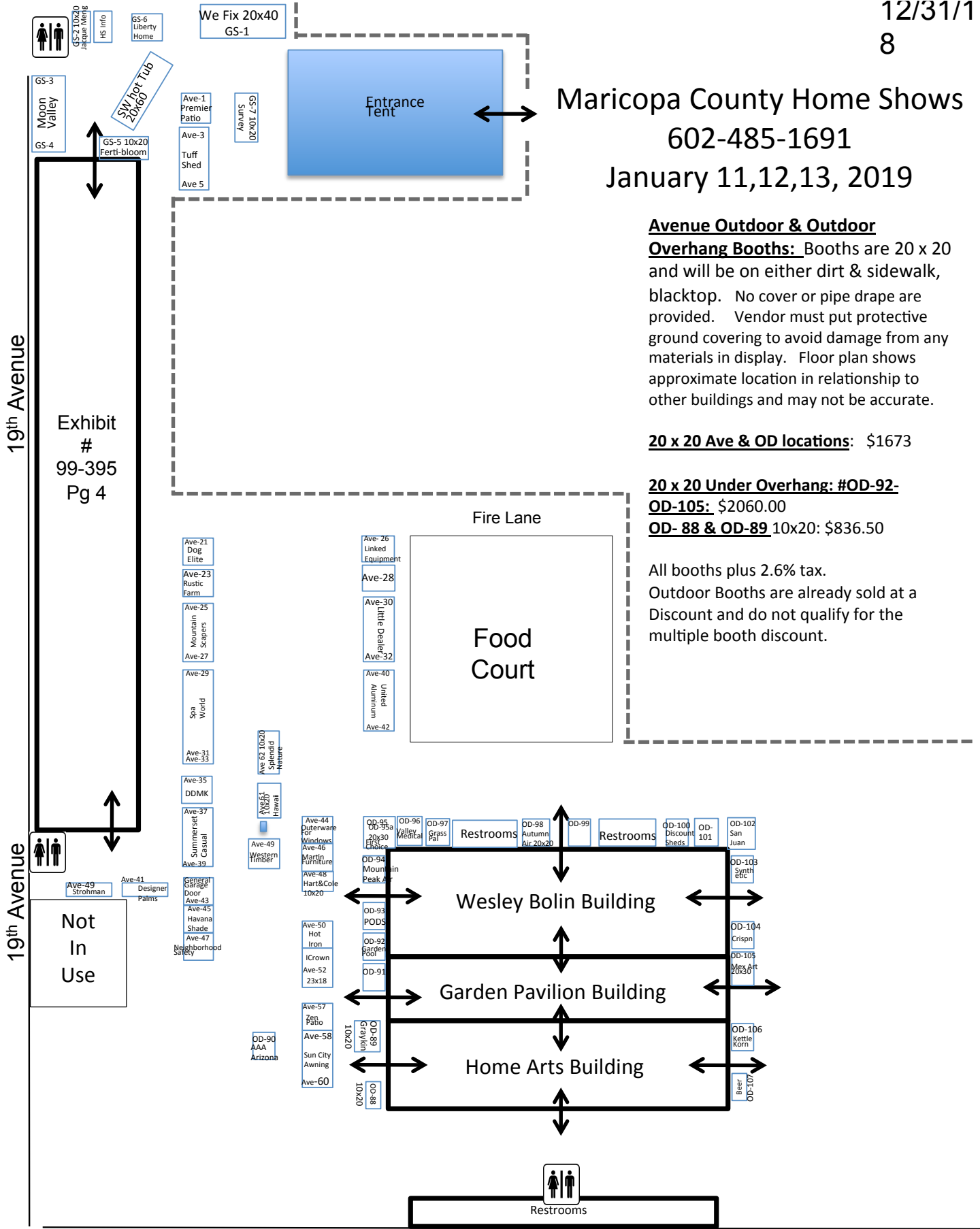

Exhibit #
99-395
Pg 4

Not
In
Use

Maricopa County Home Shows
 602-485-1691
 January 11,12,13, 2019

North Entrance Tent

Tent Descriptions:

Fully enclosed on Black Top.
 Tent is not climate controlled.
 There is overhead lighting and electricity available.

All Booths are 10 x 10 or multiples there of with the exceptions of Booths #'s 4000, 4015, 4040, 4055

Pricing:

10 x 10 Inline: \$1191
 10 x 10 Corner: \$1786.00
 All Booths Plus 2.6 % Tax
 #4000, #4015, #4040, and #4055 are 10x20 corners: \$2678

All Booths Plus 2.6 % Tax

Multiple Booth Discount:

2- 5 booths: 10%
 6 + booths: 15%
 Indicates Support Pillar
 All center row booths have a tent support pillar, please plan accordingly.

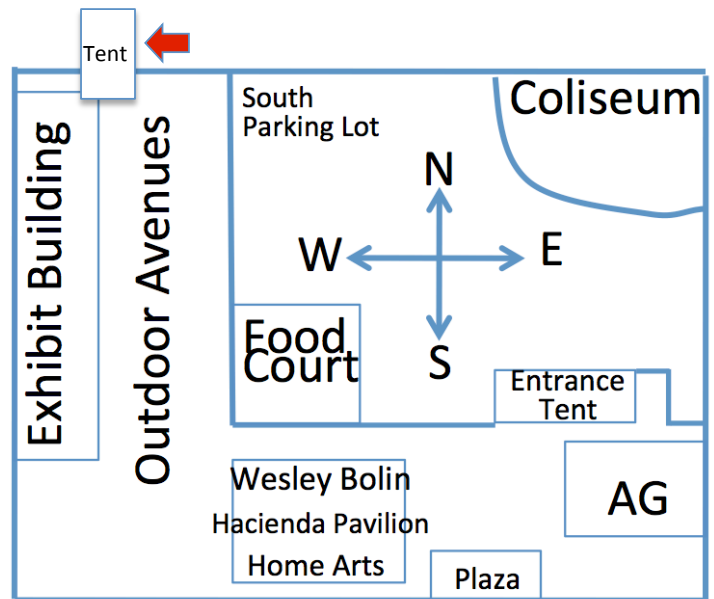
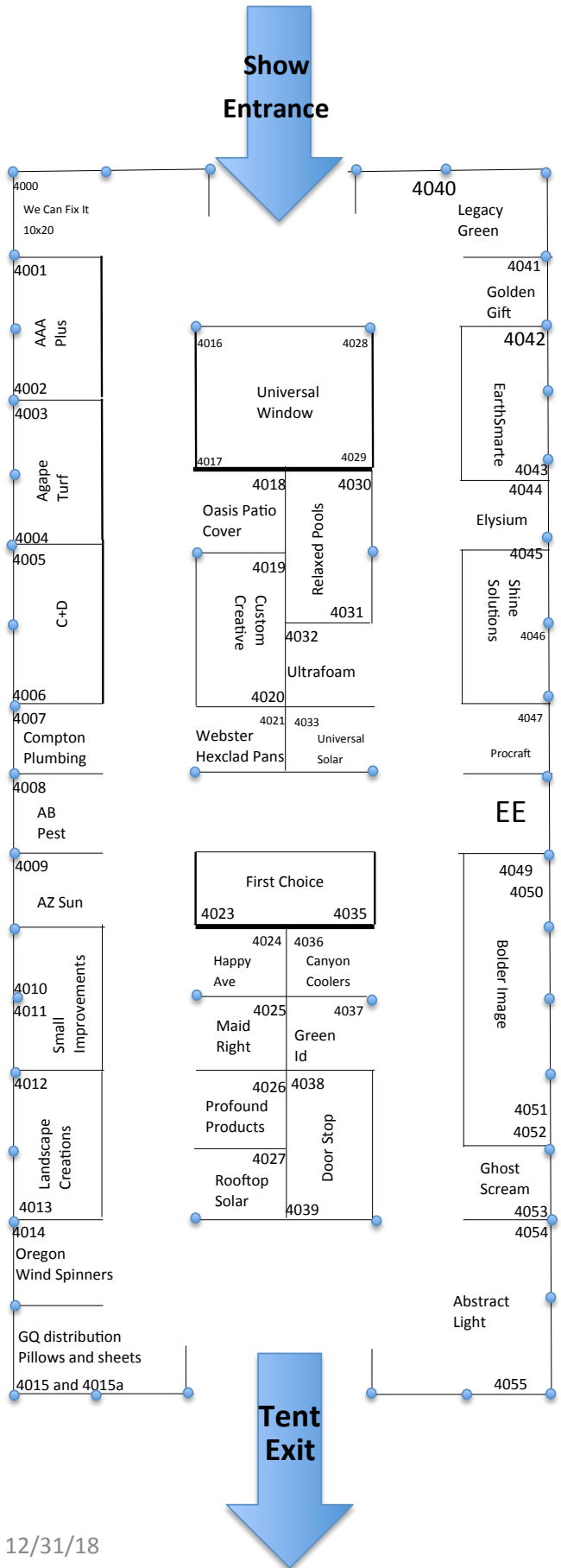

12/31/18

Arizona State Fairgrounds