

Monte Vista Parking Entrance

January 11,12,13, 2019
SHOW
OVERVIEW

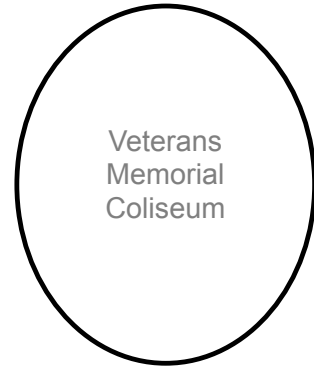

Vendor parking is located off-site at 20th Ave. & Encanto Parking Lots. Free Shuttle service will be provided for all vendors from the Vendor Lots to both show entrances.

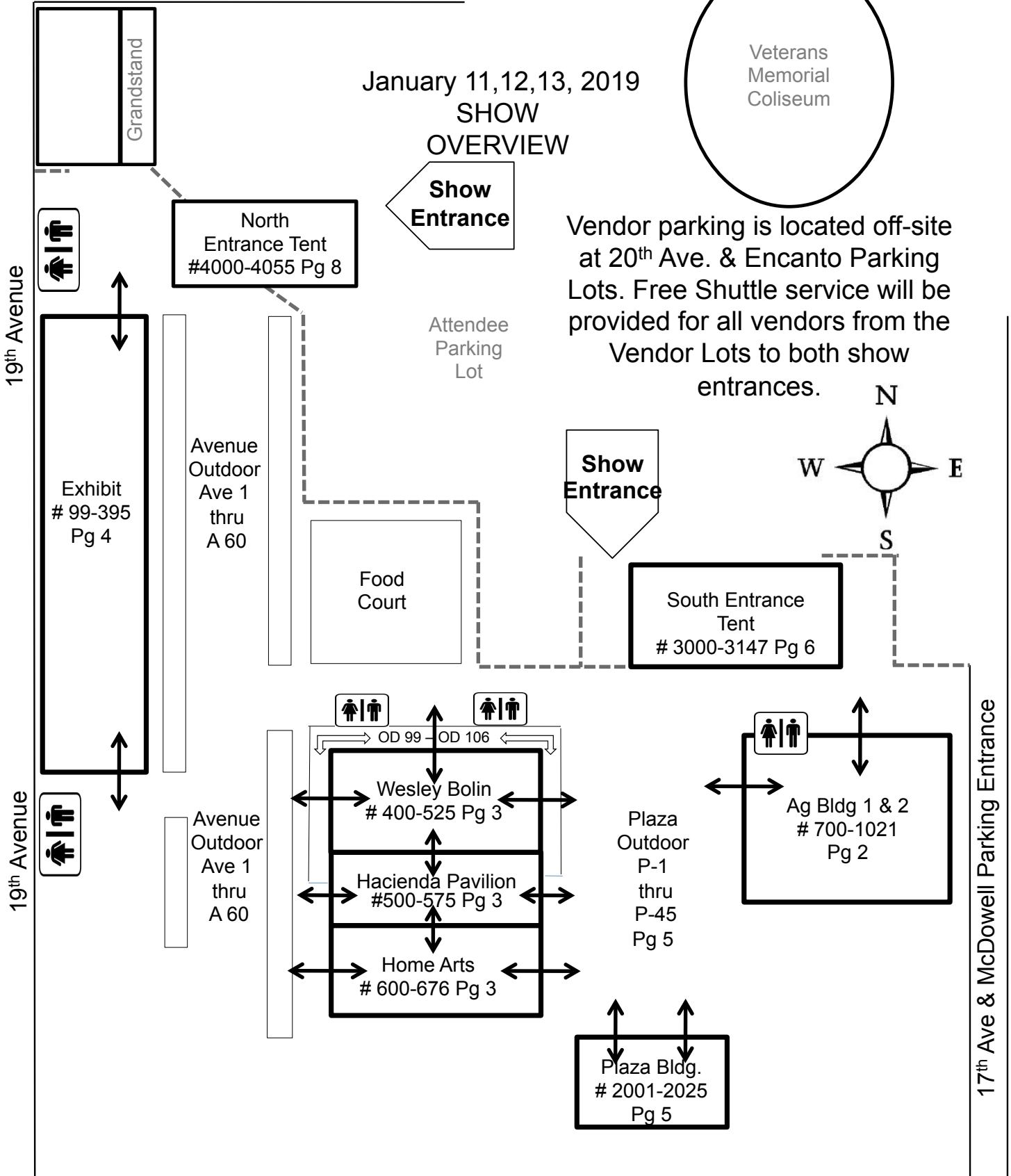
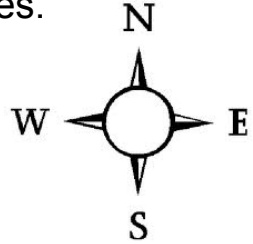

602-485-1691

Maricopa County Home Shows

12/6/18

Agricultural Building

Building Description:

Fully enclosed with concrete flooring. Climate controlled with Evaporative Cooling & Heaters.

8 x 10's = 700-713, 746-773, 806-832, 1005, 1007, 1009, 1011, 1013, 1015, 1017

Inline: \$953
Corner: \$1428

10 x 10's = All other booth numbers unless on Miscellaneous list:

10 x 10 Inline: \$1191
10 x 10 Corner: \$1786

Miscellaneous = #'s & Pricing below:

- #847 168sq. Ft. Pavilion Corner: \$3040.16
- #829 8x14 Corner: \$2273
- #831 & 1001 Pavilion Corner: \$2575
- #865 & 871 8x16 Endcap: \$2287
- #859 5x30 endcap \$2500
- #849 5x10 Corner \$893

Multiple Booth Discount:

- 2- 5 booths: 10%
- 6 + booths: 15%

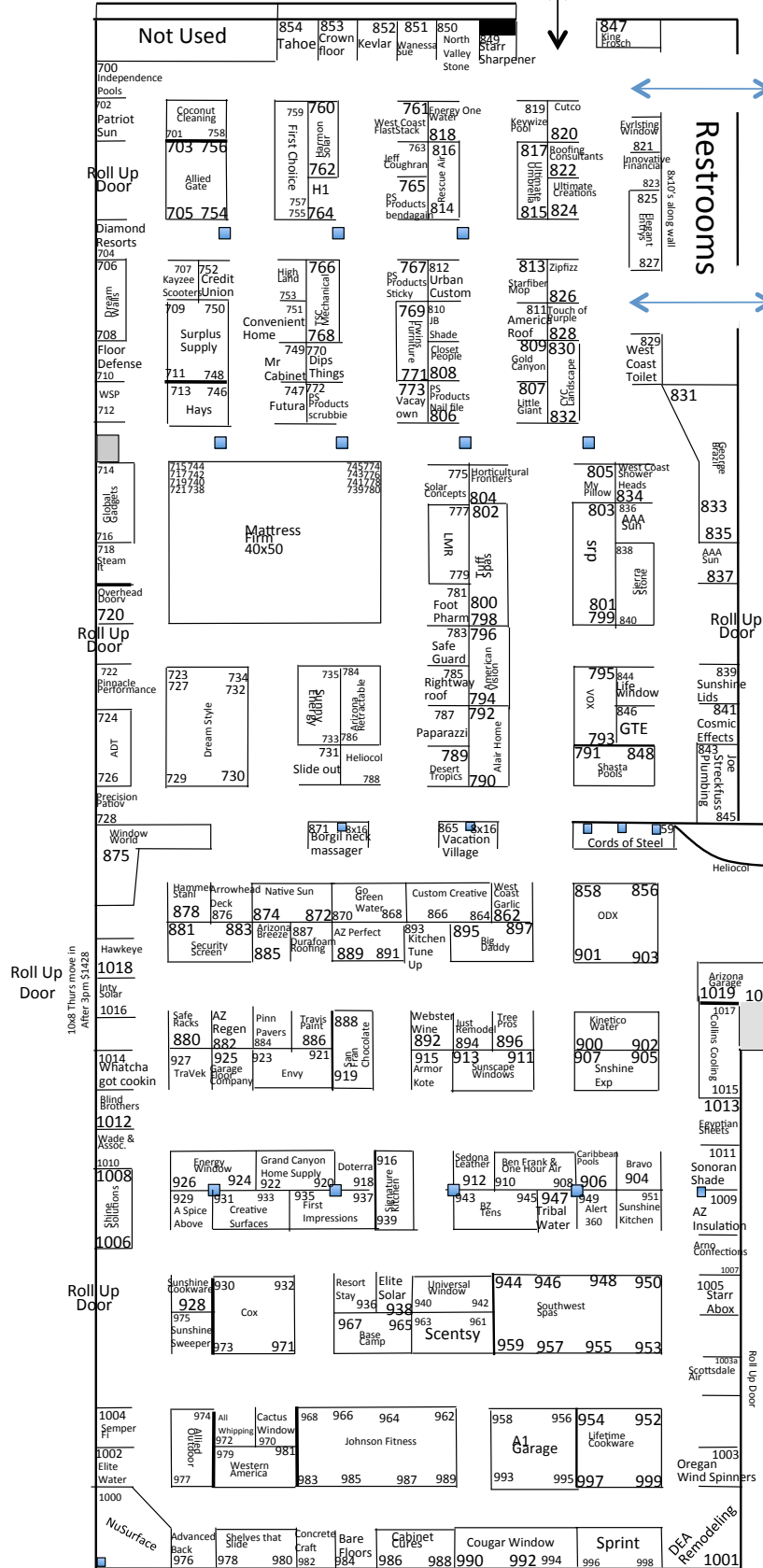

Restrooms

Roll Up Door

Roll Up Door

Roll Up Door

Roll Up Door

Show Entrance

■ = Structural Support Pillar- approx 2'x2'. Pillar location is approximate and map is not to scale.

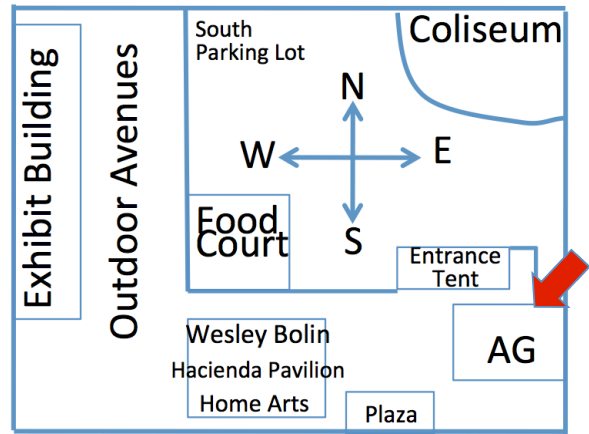

Area Description: These are 3 Separate Buildings that share the same roof and side-walls. This is the middle of the Show between both gated entrances and directly in front of the food court.

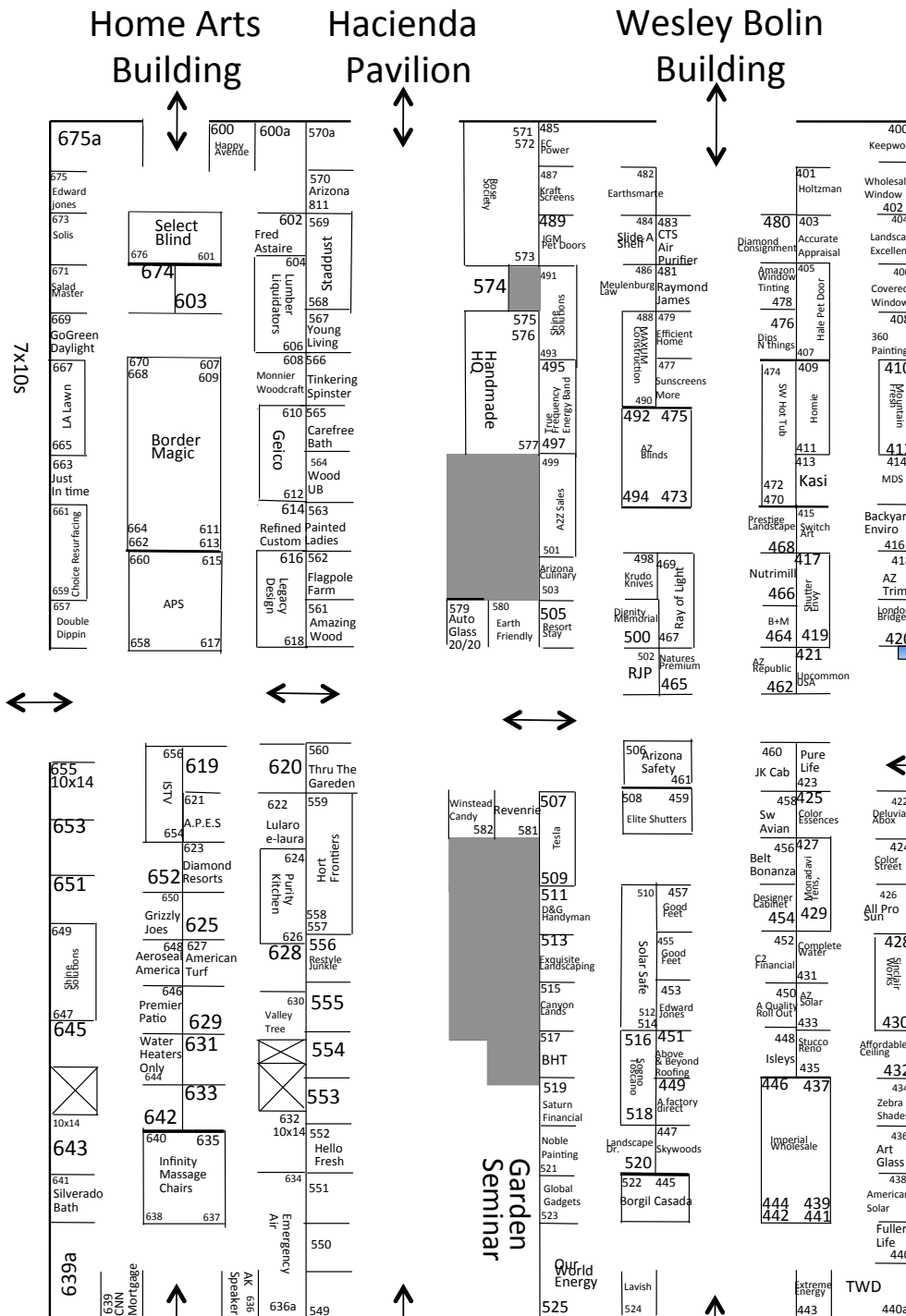

Wesley Bolin: Fully enclosed with concrete flooring. Climate controlled with Evaporative Cooling & Heaters.
8 x 10's
 Inline: \$953
 Corner: \$1428
 Pavilion Corners 525
 approx 240 sq ft.: \$2060.00
 440a-8x20 w/ 10ft opening-\$1465

Hacienda Pavilion: Has roof & side walls and is open-air breezeway with gates on either end, black top flooring. No climate control.
10 x 10's
 Inline: \$850
 Corner: \$1020
 586-589: 10 wide x8 deep open on all 3 sides \$1020
 590, 591: 6 wide x 10 deep , open on all 3 sides \$765

Home Arts: Fully enclosed with concrete flooring. No Climate control.
10 x 10's = 601-637, odds 641-655, evens 658--675
 Inline: \$1191
 Corner: \$1786

7 x 10's = evens 638-656; odds 657-673
 Inline: \$833
 Corner: \$1250

Misc - #'s & Pricing Below:
 632 & 643 10 x 14 Inline: \$1667.40
 Pavilion Corners: 600a, 636a, 639a
 Approx 200 sq ft \$1947.60
 #675a Approx 140 sq ft.: \$1786
 #655 10x14 corner: \$2262.40

Multiple Booth Discount:
 2- 5 booths: 10%
 6 + booths: 15%
 Pavilion Corners do not qualify for multiple booth discounts.

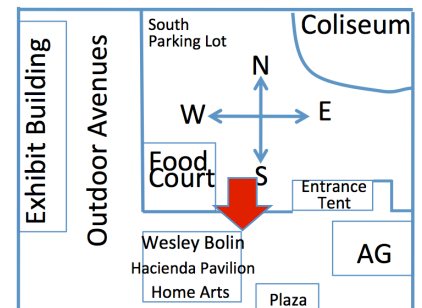

303 New A/c	301 Liberty Mutual	300 Pools	99 JLC	100 True View Window
305 Machine Store	302 Borel	201 Waterco		102 Furniture
307 GO GREEN	304 Procraft	203 Works		104 Designer
309 Azul Roofing	306 West Coast	207		108 Legends Garage
313 Select Premium Granite	310 West Coast	209		110 Phone cords
315 Forward Arch	314 West Coast	213 Window Washer		112 For Energy
317	316	215		114 Exotid. Scapes
319	318	217		116 Vactrax
321	320	219		118
323	324	223		120
325	326	225		122
327	328	227		124
329	330	229		126
Alaska USA	334	233		128
331	336	235		130
333	338	237		132
335	340	239		134
337	344	243		136
339	346	245		138
341 Sunwest	348	247		140
343	350	249		142
345	354	253		144
347	356	255		146
349 Purchase Green	358	257		148
351 Schlossader	360	259		150
353	362	261		152
355 Integrity Financial	366	263		154
357 Montenegro	368	265		156
359	370	267		158
361	374	271		160
363	376	273		162
365	378	275		164
367	380	277		166
369	384	281		168
371 Preventative Pest	386	283		170
373	388	285		172
375 Feet Solutions	392	289		174
377	398	294		176
379	399	297		178
381	399	297		180
383	399	297		182
385	399	297		184
387	399	297		184
389	399	297		184
391	399	297		184
393	399	297		184
395	399	297		184

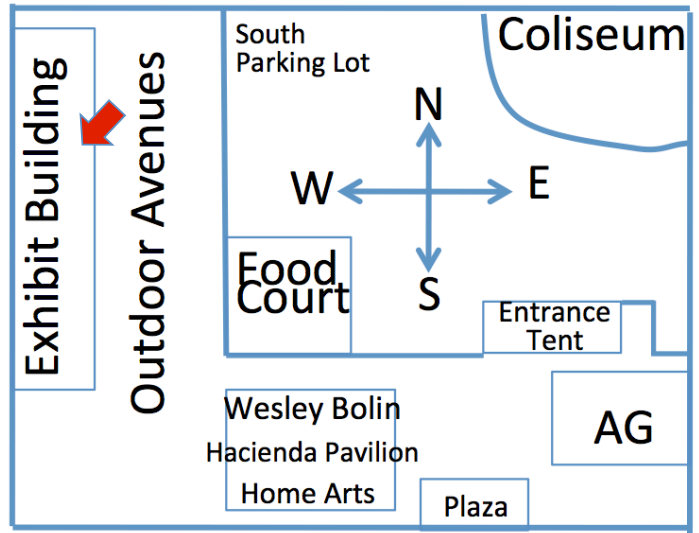

Exhibit Building

Building Descriptions:

Fully enclosed with concrete flooring. Climate controlled with Evaporative Cooling & Heaters. Heating Units are marked with ■ and some hang as low as 7 feet from the floor. All Booths are 10 x 10 or multiples there of with the exceptions of Booths 100, 303, & 395 which are Pavilion Corners (approximately 300 sq feet).

Pricing:

10 x 10 Inline: \$1191
 10 x 10 Corner: \$1786
 Pavilion Corners: \$2575.00
 184 = 10x20 corner: \$2143
 All Booths Plus 2.6 % Tax

Multiple Booth Discount:

2- 5 booths: 10%
 6 + booths: 15%

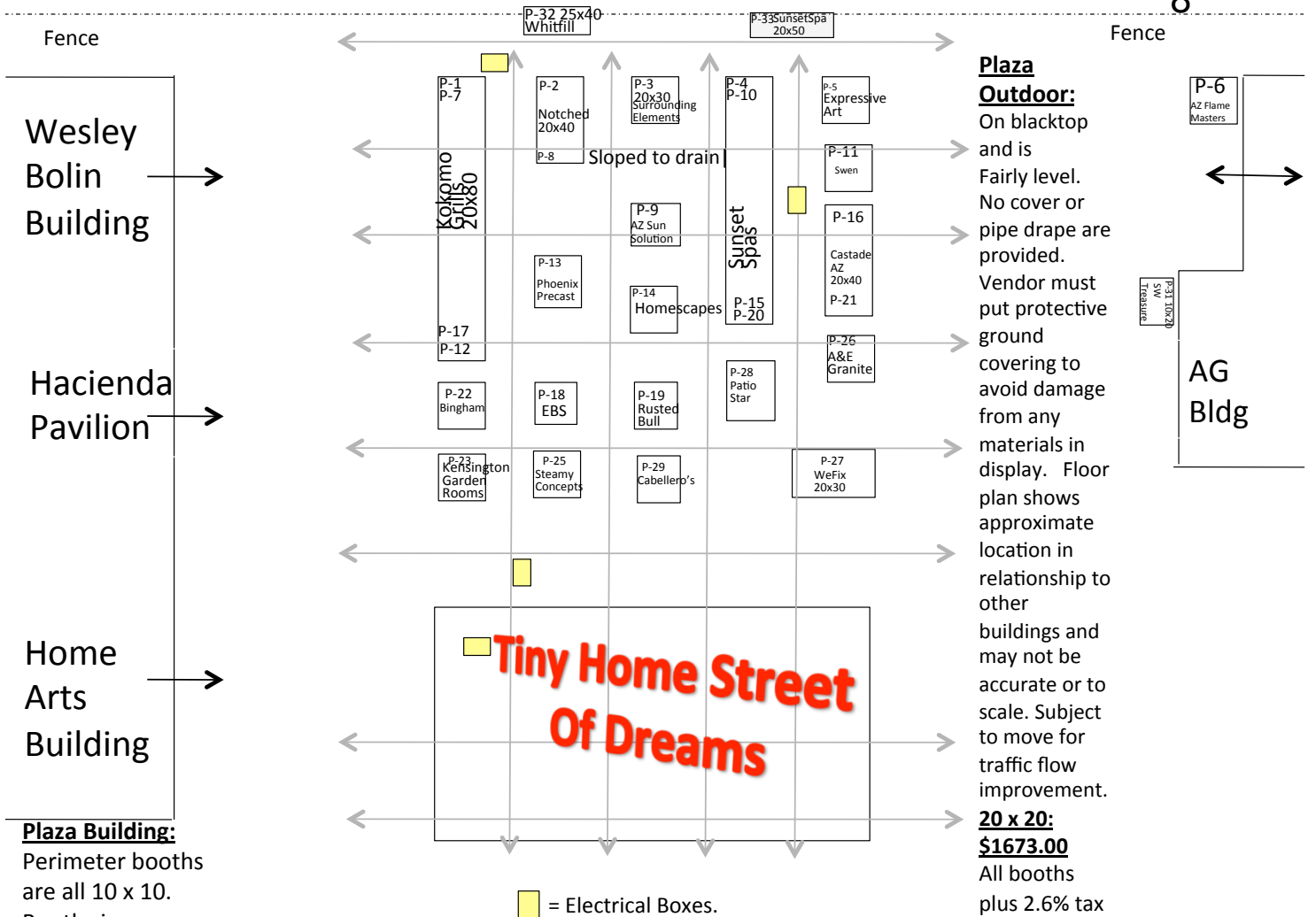

Plaza Building:

Perimeter booths are all 10 x 10. Booths in rows are all 6 x 10

10 x 10's:

Inline: \$1191
Corner: \$1786

6 x 10's:

Inline: \$715
Corner: \$1071

Pavilion Corners:

#2100 \$2143
#2001 & 2014 \$1947.60 ea
All Booths Plus 2.6 % Tax

Multiple Booth Discount:

2- 5 booths: 10%
6 + booths: 15%

Pavilion Corner + outdoor booths do not qualify for multiple booth discount.

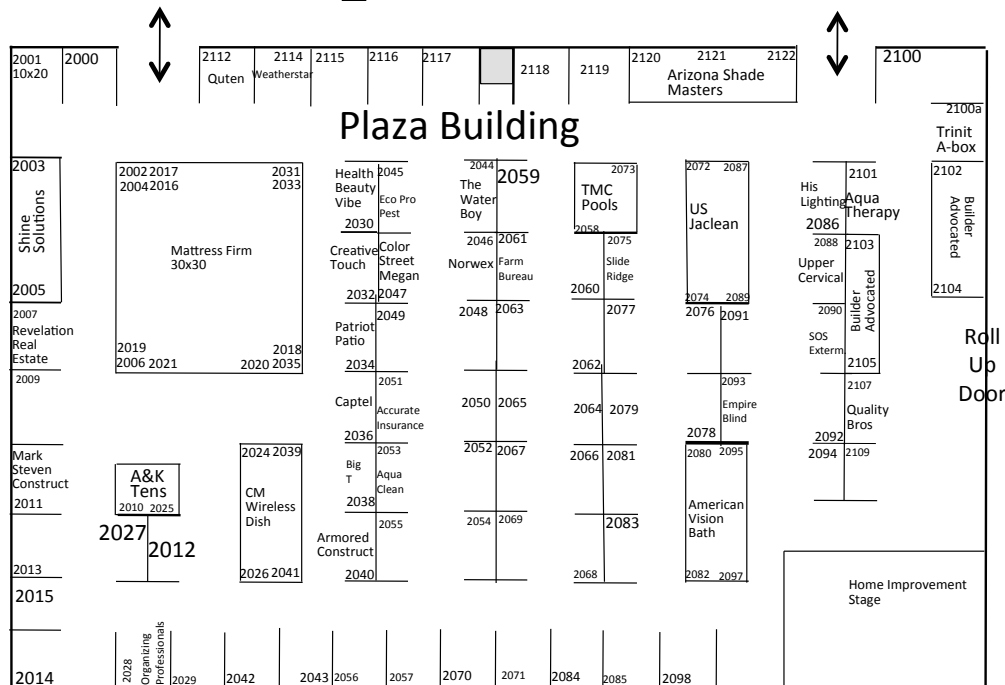

Plaza Building:
Fully enclosed with concrete flooring. Evaporative Coolers only. **NO HEATERS**

X Scooter Rentals

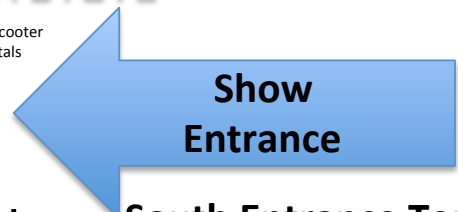

South Entrance Tent

Tent Descriptions:

Fully enclosed on Black Top.
Tent is not climate controlled.
There is overhead lighting and electricity available.

All Booths are 10 x 10 or multiples there of with the exceptions of Booths 3000, 3054, 3155.

■ Indicates Support Pillar

Pricing:

- 10 x 10 Inline: \$1191
- 10 x 10 Corner: \$1786
- Pavilion Corners: \$2575.00
- All Booths Plus 2.6 % Tax
- #3000 and #3054 are 10x20 corner: \$2679.30

Multiple Booth Discount:

- 2- 5 booths: 10%
- 6 + booths: 15%

All center row booths have a tent support pillar, please plan accordingly.

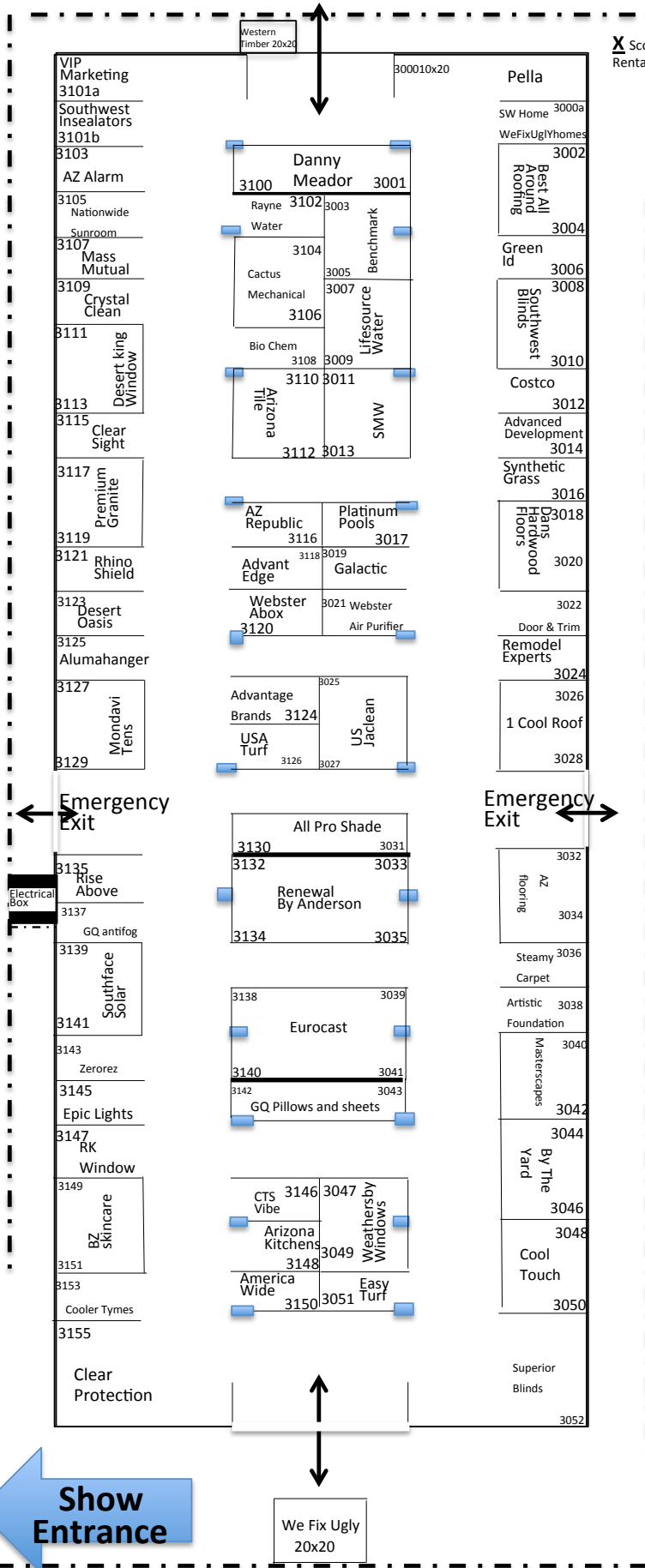
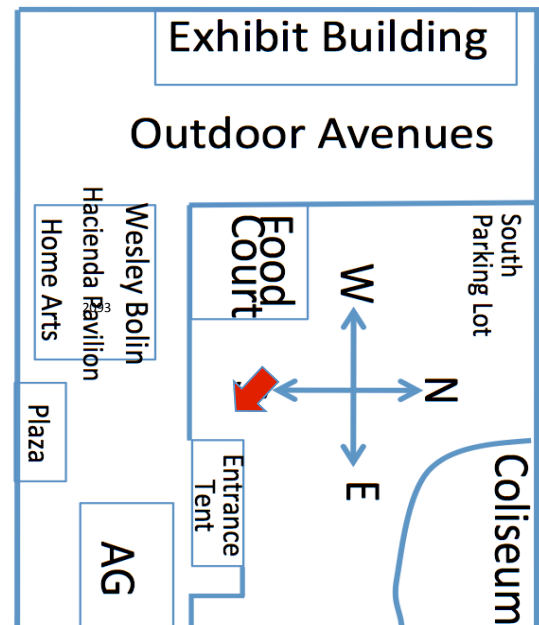

Maricopa County Home Shows 602-485-1691 January 11,12,13, 2019

Avenue Outdoor & Outdoor

Overhang Booths: Booths are 20 x 20 and will be on either dirt & sidewalk, blacktop. No cover or pipe drape are provided. Vendor must put protective ground covering to avoid damage from any materials in display. Floor plan shows approximate location in relationship to other buildings and may not be accurate.

20 x 20 Ave & OD locations: \$1673

20 x 20 Under Overhang: #OD-92-OD-105: \$2060.00

All booths plus 2.6% tax.
Outdoor Booths are already sold at a Discount and do not qualify for the multiple booth discount.

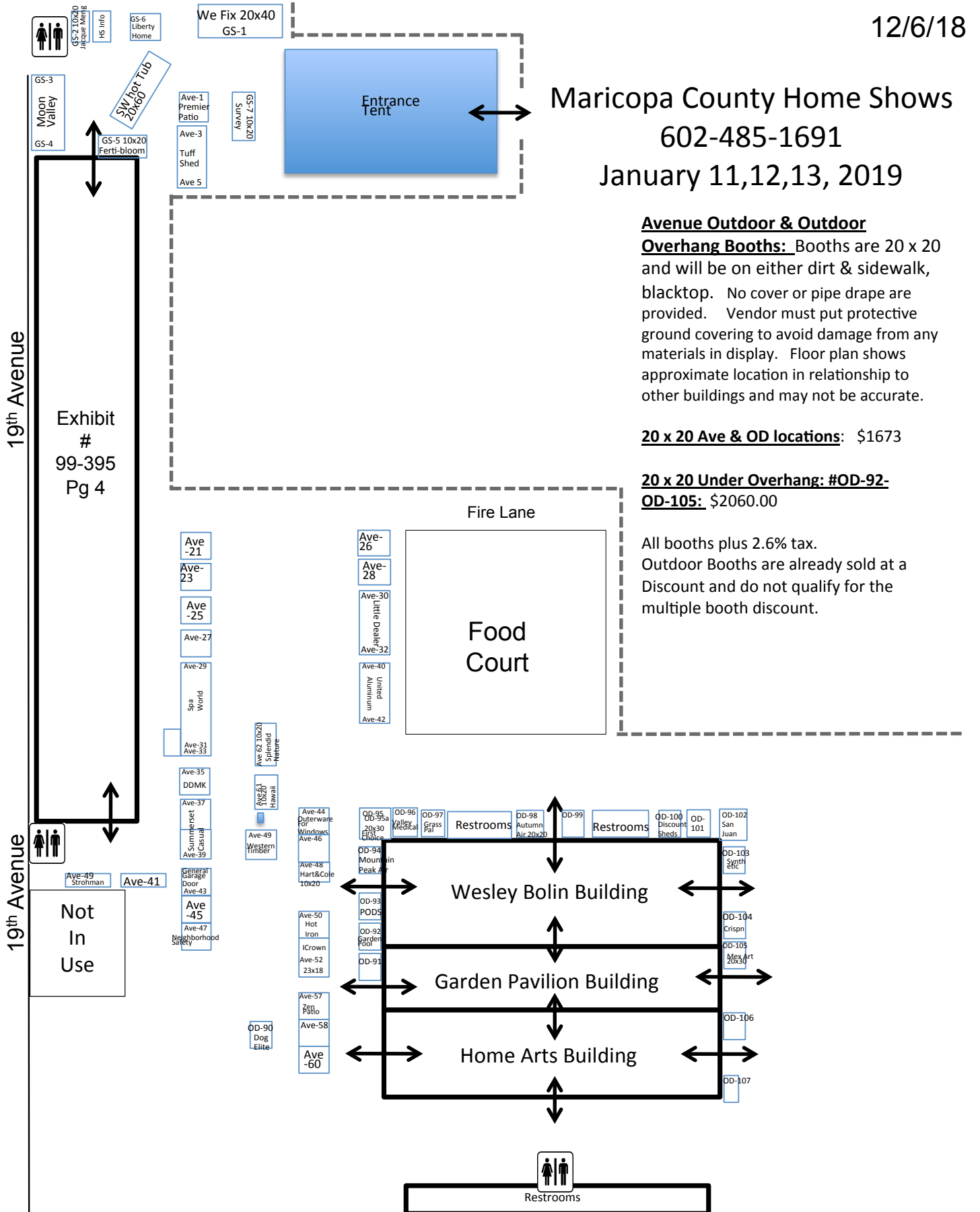

Maricopa County Home Shows
602-485-1691
January 11,12,13, 2019

North Entrance Tent

Tent Descriptions:

Fully enclosed on Black Top.
Tent is not climate controlled.
There is overhead lighting and electricity available.

All Booths are 10 x 10 or multiples there of with the exceptions of Booths#’s4000, 4015, 4040, 4055

Pricing:

10 x 10 Inline: \$1191
10 x 10 Corner: \$1786.00
All Booths Plus 2.6 % Tax
#4000, #4015, #4040, and #4055 are 10x20 corners: \$2678

All Booths Plus 2.6 % Tax

Multiple Booth Discount:

2- 5 booths: 10%
6 + booths: 15%
Indicates Support Pillar
All center row booths have a tent support pillar, please plan accordingly.

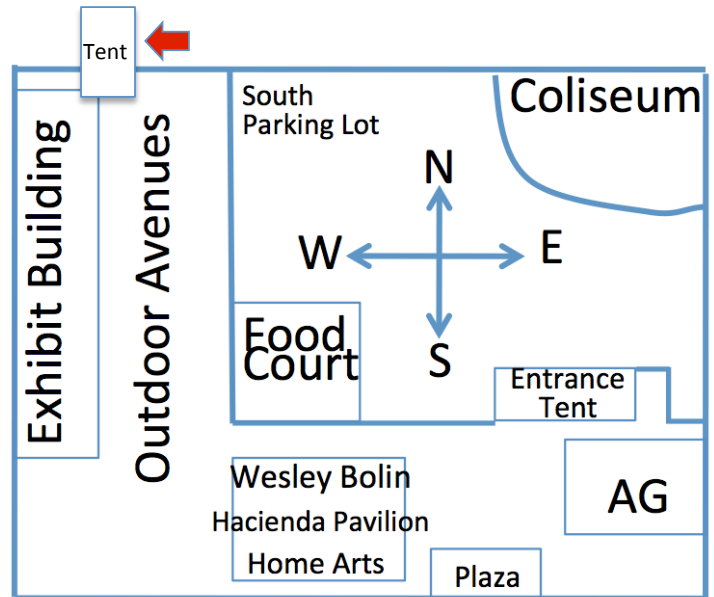
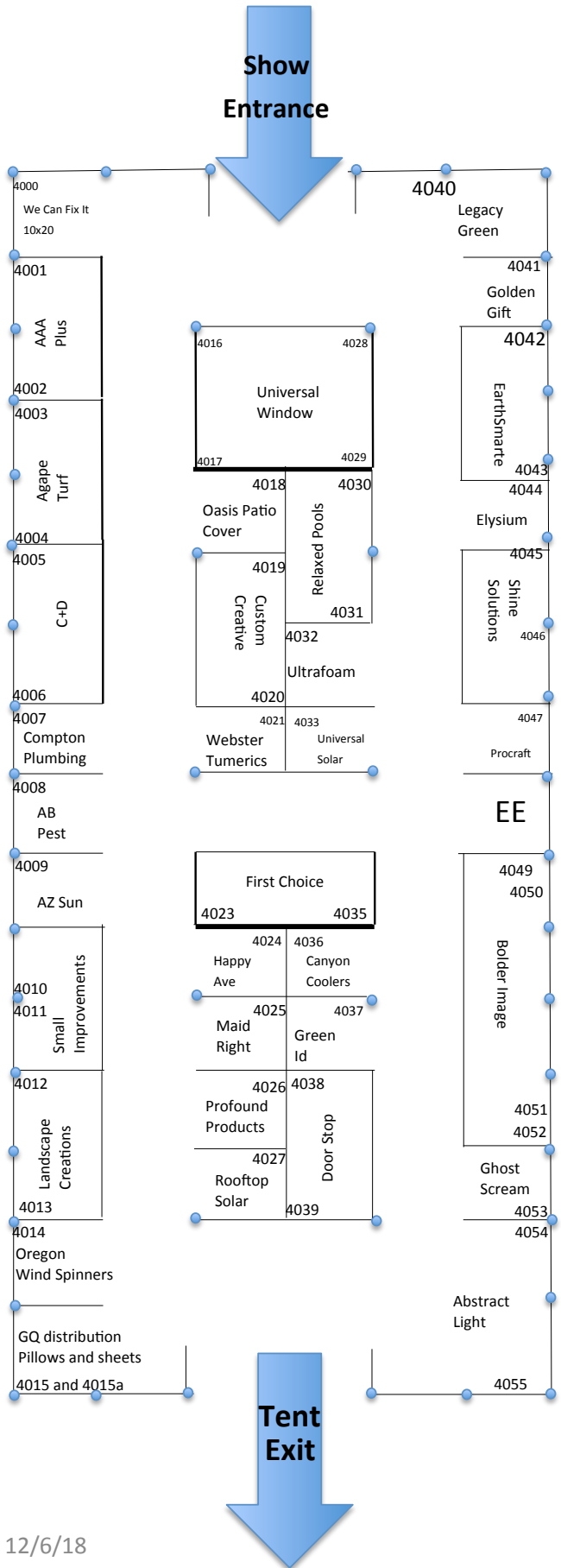

12/6/18

Arizona State Fairgrounds